



Benchtop Thermal Transfer Materials

Labels printable with benchtop thermal transfer printers

About BRADY



Once you have worked with BRADY, our name will stick with you, (just like our labels) because BRADY is one of the world's leading labelling and identification specialists.

Innovative

At BRADY we continue to improve. We have many customers from all industries, and we strive to be ahead of their needs by continuing to invest in research for even more performant solutions. By developing more user-friendly and efficient concepts, we give our thousands of customers the best in the market.

Strength

At BRADY, we believe our biggest strength is the wide range of identification and safety solutions we can offer our customers, whether it's labelling the smallest component or complete signage for an entire warehouse. We're also proud to offer many products and services - from printers, scanners and software to service contracts and on-site training - that compliment any identification job. And don't forget, our wide network of expert distributors can always offer you a tailor-made solution to meet your specific requirements.

Trust

For over a hundred years, BRADY has been connected with quality, trust and stability. We demand the best for your products and services, because we know, better than anyone, the importance of good and reliable identification. Identification looks like a small detail, but every professional knows that this kind of detail is crucial to any business.

Inform

We also have specialised dealers in your region, who can answer all your identification, safety and labelling questions, specific to your activity. They will be happy to provide you with all kinds of options and solutions with no obligation.

Microsoft is a trademark of Microsoft Corporation, Bluetooth is a trademark of Bluetooth Sig, Inc., Android is a trademark of Google Inc.



Brady products are sold on the condition that the purchaser will test them in actual use and determine for himself/herself their suitability to his/her intended purpose. Brady warrants to the purchaser that Brady products are free from defects in material and workmanship but limits its obligation under this warranty to the replacement of the product which has been shown to Brady's satisfaction to have been defective at the time of its purchase.

The warranty does not extend to any persons who have acquired the product from the purchaser. It is in lieu of any other warranty, including every warranty of sale-ability, marketability or suitability for the intended purpose, and is also in lieu of any other obligation or liability on the part of Brady.

Under no circumstances will Brady be liable for losses, damage, costs or subsequent damage of whatever nature which may arise in connection with the use of, or inability to use, Brady's products.

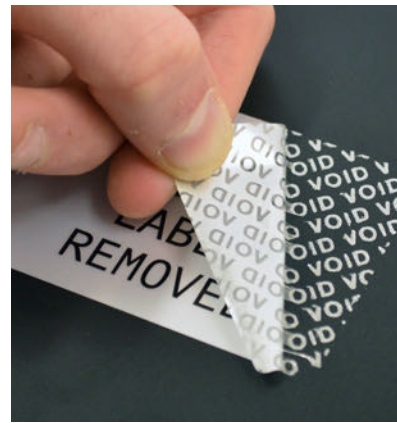
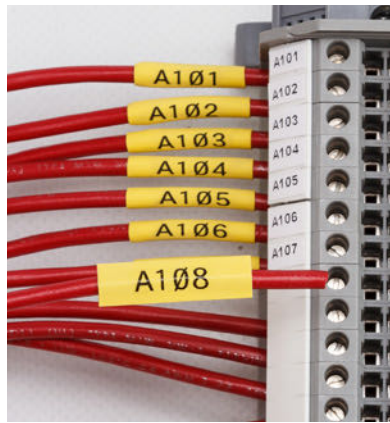

Brady benchtop thermal transfer materials

Brady's industrial materials are designed and produced to meet the exacting needs and requirements of harsh industrial environments. They are made of durable, heavy duty material and aggressive adhesive that's proven to stick to almost any industrial environment surface, including machinery, floors, walls, racks and more.

Benchtop thermal transfer materials

- 4 Performance Icons Guide
- 5 General identification and asset tracking materials
- 20 Overlaminating materials
- 22 Raised panel / Control panel materials
- 24 Circuit board materials
- 30 Tamper-evidence materials
- 32 Temperature & water-indicating materials
- 34 Wire and cable materials
- 49 Pre-printed wire markers
- 56 PermaSleeve wire marking sleeves

Benchtop thermal transfer print ribbons

- 72 Thermal transfer print ribbons
- 74 Ribbon / material cross-reference guide

▶ How to read an order reference: example THT-5-423-10

THT	-	5	-	423	-	10
Technology		Label size code		Brady material number (B-number)		Quantity: Multiply by 1,000

THT- parts: 3" (75mm) core:

Label rolls can be loaded directly in **BradyPrinter i5100** & **BradyPrinter i7100**. Labels rolls work with the **BBP12 Label Printer** using an external unwinder placed behind the printer.

THT-xx-xxx-x-SC- parts: 1" (25mm) core:

Label rolls work with **BBP12 Label Printer**. Cannot be installed inside of the other printers.

BPT- parts: 1" (25mm) core:

Label rolls work with **BBP12 Label Printer printer**. Cannot be installed inside of the other printers.



BradyPrinter i7100



BradyPrinter i5100



BBP12 Label printer

Product performance icons

Brady's implementation of a series of attribute icons provides customers with at-a-glance information on performance attributes for each of the label materials. Watch for these icons through the catalogue to help you easily identify product performance features that fit your needs.

▼ Look for these icons when using our parts catalogue, website, and more!

Abrasion resistance



Resistance proven with testing on Taber Abraser equipment with CS10 grinding wheels and weighted arms.

Electrostatic dissipative



Indicated material has surface resistivity values in the recommended range for Dissipative ESD Packaging Materials.

Fuel/Oil resistance



Resistance proven with Immersion Test in Gasoline, Break Fluid, SAE 30wt Oil, JP-8 Jet Fuel, MIL-H- 5606 Oil.

High heat resistance



Resistance to 100°C.

Low temperature resistance



Labels subjected to -40°C, -70°C or -80°C for 30 days or 1000 hours.

Outdoor durability



Favourable UV & weatherability testing equating to 3 years or greater outdoor durability.

Removable



Indicates material can be removed cleanly with no adhesive residue left on surface.

Self-extinguishing Anti-flammability



Flammability average burn time = <30 seconds
Flame spread index of 0.

Solvent/Chemical resistance



Resistance proven with MEK / Acetone / Toluene / Xylene Immersion Test.

Tamper-indicating



Materials indicate tampering through a visible fractured label or footprint.

Temperature-indicating



Indicates highest temperature exposure or current temperature.

Ultra-aggressive adhesion



Measures the force required to remove label from the surface with a 180° peel and a constant rate of 12 inch/min.

Water-indicating



Indicates presence of liquid.

► Need More Information? View The Technical Data Sheets Brady offers online access to Technical Data Sheets for all Brady materials. View by a specific B-Number or search by relevant keywords.

Visit www.bradyeurope/tds for more information.

B-408 Paper material

Colour: White

Finish: Matt

General purpose paper material for thermal transfer printing. White with matt finish and removable adhesive. Can be repositioned or removed.

Performance attributes:

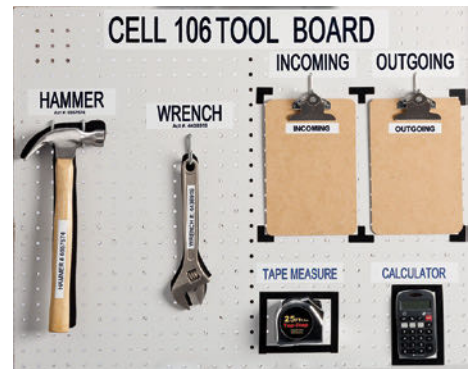
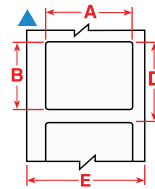

Diagram	Order Reference	Colour	Label Width A (mm)	Label Height B (mm)	Vertical Repeat D (mm)	Web Width E (mm)	Labels per Row	Labels per Roll	Printer Compatibility	Ribbon Series
B-408 : Repositionable Paper										
▲	THT-17-408-3	White	50.80	25.40	28.58	55.88	1	3000	BBP12, i7100, i5100	R7942/R6100
▲	THT-18-408-3	White	76.20	25.40	28.58	81.28	1	3000	BBP12, i7100, i5100	R7942/R6100
▲	THT-19-408-1	White	76.20	50.80	53.98	81.28	1	1000	BBP12, i7100, i5100	R7942/R6100
▲	THT-20-408-1	White	76.20	127.00	130.18	81.28	1	1000	BBP12, i7100, i5100	R7942/R6100
▲	THT-55-408-1	White	101.60	50.80	53.98	106.68	1	1000	BBP12, i7100, i5100	R7942/R6100
▲	THT-25-408-1	White	101.60	152.40	155.58	106.68	1	1000	BBP12, i7100, i5100	R7942/R6100
▲	THT-78-408-1	White	101.60	165.10	168.28	106.68	1	1000	BBP12, i7100, i5100	R7942/R6100

B-413 Polyester material

Colour: Light Grey

Finish: Satin

Thermal transfer printable polyester material with metallic looking finish (non-metallised). Ideal for barcoded asset tracking and rating plate applications.

Performance attributes:

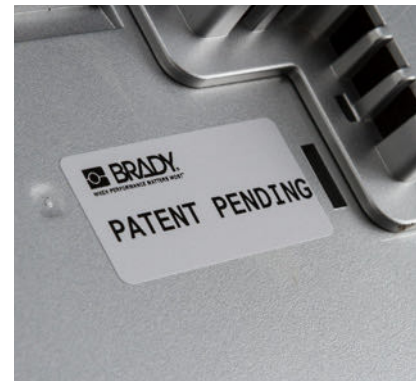
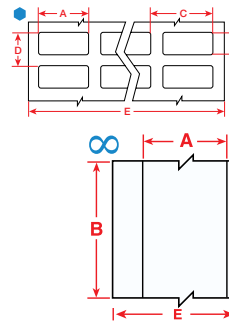

Diagram	Order Reference	Colour	Label Width A (mm)	Label Height B (mm)	Label Length B (m)	Vertical Repeat D (mm)	Web Width E (mm)	Labels per Row	Labels per Roll	Printer Compatibility	Ribbon Series
B-413 : Metallic, Non-metal Polyester											
●	THT-12-413-10	Light Grey	12.70	11.10		13.64	85.09	5	10000	i7100, i5100	R6000HF
●	THT-1-413-10	Light Grey	19.05	6.35		8.89	85.09	4	10000	BBP12, i7100, i5100	R6000HF
●	THT-3-413-10	Light Grey	25.40	9.53		12.07	85.09	3	10000	BBP12, i7100, i5100	R6000HF
●	THT-5-413-10	Light Grey	25.40	12.70		15.24	85.09	3	10000	BBP12, i7100, i5100	R6000HF
●	THT-37-413-10	Light Grey	38.10	12.70		15.24	85.09	2	10000	BBP12, i7100, i5100	R6000HF
●	THT-6-413-10	Light Grey	38.10	19.05		22.23	85.09	2	10000	BBP12, i7100, i5100	R6000HF
▲	THT-53-413-3	Light Grey	50.80	12.70		15.24	55.88	1	3000	BBP12, i7100, i5100	R6000HF
▲	THT-17-413-3	Light Grey	50.80	25.40		28.58	55.88	1	3000	BBP12, i7100, i5100	R6000HF
∞	THT-106-413	Light Grey	50.80	-	91.44 m	-	55.88	1	1	BBP12, i7100, i5100	R6000HF
▲	THT-7-413-3	Light Grey	69.85	31.75		34.93	74.93	1	3000	BBP12, i7100, i5100	R6000HF
▲	THT-18-413-3	Light Grey	76.20	25.40		28.58	81.28	1	3000	BBP12, i7100, i5100	R6000HF
▲	THT-19-413-1	Light Grey	76.20	50.80		53.98	81.28	1	1000	BBP12, i7100, i5100	R6000HF
∞	THT-21-413	Light Grey	76.20	-	91.44 m	-	81.28	1	1	BBP12, i7100, i5100	R6000HF
▲	THT-55-413-1	Light Grey	101.60	50.80		53.98	106.68	1	1000	BBP12, i7100, i5100	R6000HF
∞	THT-107-413	Light Grey	101.60	-	91.44 m	-	106.68	1	1	BBP12, i7100, i5100	R6000HF

General identification and asset tracking materials



B-422 Polyester material

Colour: White

Finish: Gloss

White polyester with glossy finish and 0.0508 millimeter of adhesive for rough surface applications, including low surface energy plastics. Designed to withstand solvent exposure. UL rated for surfaces commonly used in solar panel manufacturing. Also used for component identification, barcoding, asset and inventory tracking.

Performance attributes:

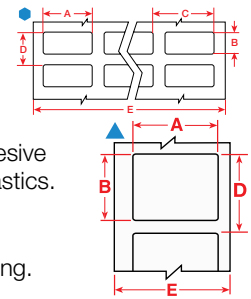

Diagram	Order Reference	Colour	Label Width A (mm)	Label Height B (mm)	Vertical Repeat D (mm)	Web Width E (mm)	Labels per Row	Labels per Roll	Printer Compatibility	Ribbon Series
B-422 : Polyester										
●	THT-36-422-10	White	12.70	5.08	7.62	81.28	5	10000	BBP12, i7100, i5100	R6000HF
●	THT-5-422-10	White	25.40	12.70	15.24	85.09	3	10000	BBP12, i7100, i5100	R6000HF
▲	THT-102-422-10	White	38.10	9.53	12.70	43.18	1	10000	BBP12, i7100, i5100	R6000HF
●	THT-147-422-10	White	38.10	9.53	12.07	85.09	2	10000	BBP12, i7100, i5100	R6000HF
▲	THT-17-422-3	White	50.80	25.40	28.58	55.88	1	3000	BBP12, i7100, i5100	R6000HF
▲	THT-7-422-3	White	69.85	31.75	34.93	74.93	1	3000	BBP12, i7100, i5100	R6000HF
▲	THT-18-422-3	White	76.20	25.40	28.58	81.28	1	3000	BBP12, i7100, i5100	R6000HF
▲	THT-19-422-1	White	76.20	50.80	53.98	81.28	1	1000	BBP12, i7100, i5100	R6000HF
▲	THT-76-422-1	White	101.60	76.20	79.38	106.68	1	1000	BBP12, i7100, i5100	R6000HF



B-423 Polyester material

Colour: White/Yellow

Finish: Gloss

White polyester thermal transfer printable material with a glossy finish. Widely used for component identification, barcoding, asset and inventory tracking. UL rated for surfaces commonly used in solar panel manufacturing.

Performance attributes:

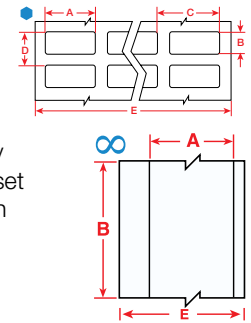

Diagram	Order Reference	Colour	Label Width A (mm)	Label Height B (mm)	Label Length B (m)	Vertical Repeat D (mm)	Web Width E (mm)	Labels per Row	Labels per Roll	Printer Compatibility	Ribbon Series
B-423 : Polyester											
●	THT-11-423-10	White	6.35	6.35	-	9.53	81.28	12	10000	BBP12, i7100, i5100	R6000HF
●	THT-38-423-10	White	9.53	9.53	-	12.07	81.28	7	10000	i7100, i5100	R6000HF
▲	THT-97-423-10	White	12.70	5.08	-	7.62	17.78	1	10000	BBP12, i7100, i5100	R6000HF
●	THT-36-423-10	White	12.70	5.08	-	7.62	81.28	5	10000	BBP12, i7100, i5100	R6000HF
●	THT-12-423-10	White	12.70	11.10	-	13.64	85.09	5	10000	i7100, i5100	R6000HF
●	THT-14-423-10	White	16.51	5.08	-	7.62	74.93	4	10000	BBP12, i7100, i5100	R6000HF
▲	THT-47-423-10	White	16.51	5.08	-	7.62	21.59	1	10000	BBP12, i7100, i5100	R6000HF
●	THT-57-423-10	White	17.78	9.53	-	12.07	85.09	4	10000	BBP12, i7100, i5100	R6000HF
●	THT-1-423-10	White	19.05	6.35	-	8.89	85.09	4	10000	BBP12, i7100, i5100	R6000HF
▲	THT-46-423-10	White	19.05	6.35	-	8.89	24.13	1	10000	BBP12, i7100, i5100	R6000HF
●	THT-50-423-10	White	19.05	19.05	-	22.23	85.09	4	10000	BBP12, i7100, i5100	R6000HF
●	THT-2-423-10	White	22.86	6.35	-	8.89	85.09	3	10000	BBP12, i7100, i5100	R6000HF
▲	THT-49-423-10	White	22.86	6.35	-	8.89	27.94	1	10000	BBP12, i7100, i5100	R6000HF
●	THT-41-423-10	White	25.40	4.75	-	7.29	85.09	3	10000	BBP12, i7100, i5100	R6000HF
▲	THT-42-423-10	White	25.40	4.75	-	7.29	30.48	1	10000	BBP12, i7100, i5100	R6000HF
▲	THT-103-423-10	White	25.40	6.35	-	8.89	30.48	1	10000	BBP12, i7100, i5100	R6000HF
●	THT-51-423-10	White	25.40	6.35	-	9.53	85.09	3	10000	BBP12, i7100, i5100	R6000HF
●	THT-3-423-10	White	25.40	9.53	-	12.07	85.09	3	10000	BBP12, i7100, i5100	R6000HF
▲	THT-59-423-10	White	25.40	12.70	-	15.24	30.48	1	10000	BBP12, i7100, i5100	R6000HF
●	THT-5-423-10-YL	Yellow	25.40	12.70	-	15.24	85.09	3	10000	BBP12, i7100, i5100	R6000HF
●	THT-5-423-10	White	25.40	12.70	-	15.24	85.09	3	10000	BBP12, i7100, i5100	R6000HF
●	THT-31-423-10	White	27.94	9.65	-	12.70	63.50	2	10000	BBP12, i7100, i5100	R6000HF

>>

B-423 Polyester material (continued)

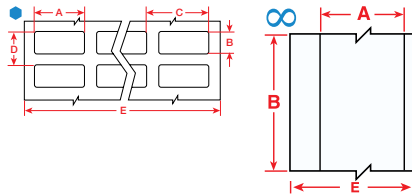

Diagram	Order Reference	Colour	Label Width A (mm)	Label Height B (mm)	Label Length B (m)	Vertical Repeat D (mm)	Web Width E (mm)	Labels per Row	Labels per Roll	Printer Compatibility	Ribbon Series
B-423 : Polyester											
●	THT-13-423-10	White	31.75	6.35	–	9.53	69.85	2	10000	BBP12, i7100, i5100	R6000HF
▲	THT-43-423-10	White	31.75	6.35	–	8.89	36.83	1	10000	BBP12, i7100, i5100	R6000HF
●	THT-29-423-10	White	31.75	9.53	–	12.07	69.85	2	10000	BBP12, i7100, i5100	R6000HF
●	THT-40-423-10	White	34.93	6.35	–	9.53	77.47	2	10000	BBP12, i7100, i5100	R6000HF
▲	THT-44-423-10	White	34.93	6.35	–	8.89	40.64	1	10000	BBP12, i7100, i5100	R6000HF
●	THT-28-423-10	White	38.10	3.18	–	6.35	85.09	2	10000	i7100, i5100	R6000HF
●	THT-4-423-10	White	38.10	6.35	–	8.89	85.09	2	10000	BBP12, i7100, i5100	R6000HF
▲	THT-45-423-10	White	38.10	6.35	–	8.89	43.18	1	10000	BBP12, i7100, i5100	R6000HF
●	THT-37-423-10-YL	Yellow	38.10	12.70	–	15.24	85.09	2	10000	BBP12, i7100, i5100	R6000HF
●	THT-37-423-10	White	38.10	12.70	–	15.24	85.09	2	10000	BBP12, i7100, i5100	R6000HF
●	THT-6-423-10-YL	Yellow	38.10	19.05	–	22.23	85.09	2	10000	BBP12, i7100, i5100	R6000HF
●	THT-6-423-10	White	38.10	19.05	–	22.23	85.09	2	10000	BBP12, i7100, i5100	R6000HF
▲	THT-15-423-2.5	White	50.80	6.35	–	9.53	55.88	1	2500	BBP12, i7100, i5100	R6000HF
▲	THT-48-423-10	White	50.80	6.35	–	8.89	55.88	1	10000	BBP12, i7100, i5100	R6000HF
▲	THT-79-423-10	White	50.80	10.16	–	12.70	55.88	1	10000	BBP12, i7100, i5100	R6000HF
▲	THT-53-423-3	White	50.80	12.70	–	15.24	55.88	1	3000	BBP12, i7100, i5100	R6000HF
●	THT-17-423-3-YL	Yellow	50.80	25.40	–	28.58	55.88	1	3000	BBP12, i7100, i5100	R6000HF
▲	THT-17-423-3	White	50.80	25.40	–	28.58	55.88	1	3000	BBP12, i7100, i5100	R6000HF
▲	THT-142-423-2.5	White	63.50	5.08	–	7.62	68.58	1	2500	BBP12, i7100, i5100	R6000HF
▲	THT-7-423-3	White	69.85	31.75	–	34.93	74.93	1	3000	BBP12, i7100, i5100	R6000HF
▲	THT-16-423-2.5	White	76.20	6.35	–	9.53	81.28	1	2500	BBP12, i7100, i5100	R6000HF
●	THT-18-423-3-YL	Yellow	76.20	25.40	–	28.58	81.28	1	3000	BBP12, i7100, i5100	R6000HF
▲	THT-18-423-3	White	76.20	25.40	–	28.58	81.28	1	3000	BBP12, i7100, i5100	R6000HF
●	THT-19-423-1-YL	Yellow	76.20	50.80	–	53.98	81.28	1	1000	BBP12, i7100, i5100	R6000HF
▲	THT-19-423-1	White	76.20	50.80	–	53.98	81.28	1	1000	BBP12, i7100, i5100	R6000HF
∞	THT-21-423	White	76.20	–	91.44 m	–	81.28	1	1	BBP12, i7100, i5100	R6000HF
●	THT-55-423-1-YL	Yellow	101.60	50.80	–	53.98	106.68	1	1000	BBP12, i7100, i5100	R6000HF
▲	THT-55-423-1	White	101.60	50.80	–	53.98	106.68	1	1000	BBP12, i7100, i5100	R6000HF

B-424 Paper material

Colour: White

Finish: Matt

White paper material with matt finish and smooth top coat finish for thermal transfer printing. Good contrast and smear resistance for thermal barcode printing. Used for general purpose labelling applications.

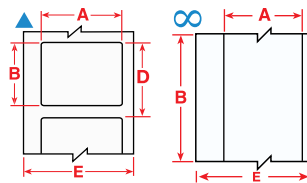

Performance attributes:



Diagram	Order Reference	Colour	Label Width A (mm)	Label Height B (mm)	Label Length B (m)	Vertical Repeat D (mm)	Web Width E (mm)	Labels per Row	Labels per Roll	Printer Compatibility	Ribbon Series
B-424 : Paper											
▲	THT-53-424-3	White	50.80	12.70	–	15.24	55.88	1	3000	BBP12, i7100, i5100	R4300, R7950
▲	THT-17-424-3	White	50.80	25.40	–	28.58	55.88	1	3000	BBP12, i7100, i5100	R4300, R7950
▲	THT-7-424-3	White	69.85	31.75	–	34.93	74.93	1	3000	BBP12, i7100, i5100	R4300, R7950
▲	THT-18-424-3	White	76.20	25.40	–	28.58	81.28	1	3000	BBP12, i7100, i5100	R4300, R7950
▲	THT-19-424-1	White	76.20	50.80	–	53.98	81.28	1	1000	BBP12, i7100, i5100	R4300, R7950
▲	THT-20-424-1	White	76.20	127.00	–	130.18	81.28	1	1000	BBP12, i7100, i5100	R4300, R7950
∞	THT-21-424	White	76.20	–	91.44 m	–	81.28	1	1	BBP12, i7100, i5100	R4300, R7950
▲	THT-55-424-1	White	101.60	50.80	–	53.98	106.68	1	1000	BBP12, i7100, i5100	R4300, R7950
▲	THT-25-424-1	White	101.60	152.40	–	155.58	106.68	1	1000	BBP12, i7100, i5100	R4300, R7950

General identification and asset tracking materials



B-425 Polypropylene material

Colour: White

Finish: Matt

White polypropylene material stock with matt finish for thermal transfer printing or write-on applications. Excellent solvent resistance and print performance; not recommended for long-term outdoor use.

Performance attributes:

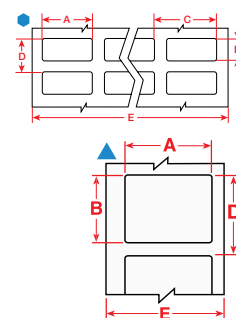

Diagram	Order Reference	Colour	Label Width A (mm)	Label Height B (mm)	Vertical Repeat D (mm)	Web Width E (mm)	Labels per Row	Labels per Roll	Printer Compatibility	Ribbon Series
B-425A : Polypropylene										
●	THT-30-425-10	White	25.40	10.00	12.70	85.09	3	10000	BBP12, i7100, i5100	R6400
●	THT-5-425-10	White	25.40	12.70	15.24	85.09	3	10000	BBP12, i7100, i5100	R6400
▲	THT-17-425-3	White	50.80	25.40	28.58	55.88	1	3000	BBP12, i7100, i5100	R6400
▲	THT-7-425-3	White	69.85	31.75	34.93	74.93	1	3000	BBP12, i7100, i5100	R6400
▲	THT-18-425-3	White	76.20	25.40	28.58	81.28	1	3000	BBP12, i7100, i5100	R6400
▲	THT-19-425-1	White	76.20	50.80	53.98	81.28	1	1000	BBP12, i7100, i5100	R6400
▲	THT-20-425-1	White	76.20	127.00	130.18	81.28	1	1000	BBP12, i7100, i5100	R6400
▲	THT-55-425-1	White	101.60	50.80	53.98	106.68	1	1000	BBP12, i7100, i5100	R6400
▲	THT-76-425-1	White	101.60	76.20	79.38	106.68	1	1000	BBP12, i7100, i5100	R6400



B-428 Polyester material

Colour: Light Grey

Finish: Matt

Thermal transfer printable metallised polyester with matt finish. Withstands solvents and variable temperatures. Excellent for serial and rating plate applications with nameplate quality and a metallic finish.

Performance attributes:

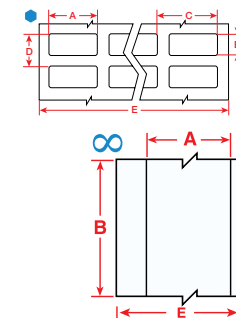

Diagram	Order Reference	Colour	Label Width A (mm)	Label Height B (mm)	Label Length B (m)	Vertical Repeat D (mm)	Web Width E (mm)	Labels per Row	Labels per Roll	Printer Compatibility	Ribbon Series
B-428 : Metallised Polyester											
●	THT-12-428-10	Light Grey	12.70	11.10	-	13.64	85.09	5	10000	i7100, i5100	R4300, R7950
●	THT-1-428-10	Light Grey	19.05	6.35	-	8.89	85.09	4	10000	BBP12, i7100, i5100	R4300, R7950
●	THT-3-428-10	Light Grey	25.40	9.53	-	12.07	85.09	3	10000	BBP12, i7100, i5100	R4300, R7950
●	THT-5-428-10	Light Grey	25.40	12.70	-	15.24	85.09	3	10000	BBP12, i7100, i5100	R4300, R7950
●	THT-37-428-10	Light Grey	38.10	12.70	-	15.24	85.09	2	10000	BBP12, i7100, i5100	R4300, R7950
●	THT-6-428-10	Light Grey	38.10	19.05	-	22.23	85.09	2	10000	BBP12, i7100, i5100	R4300, R7950
▲	THT-53-428-3	Light Grey	50.80	12.70	-	15.24	55.88	1	3000	BBP12, i7100, i5100	R4300, R7950
▲	THT-17-428-3	Light Grey	50.80	25.40	-	28.58	55.88	1	3000	BBP12, i7100, i5100	R4300, R7950
▲	THT-7-428-3	Light Grey	69.85	31.75	-	34.93	74.93	1	3000	BBP12, i7100, i5100	R4300, R7950
▲	THT-18-428-3	Light Grey	76.20	25.40	-	28.58	81.28	1	3000	BBP12, i7100, i5100	R4300, R7950
▲	THT-19-428-1	Light Grey	76.20	50.80	-	53.98	81.28	1	1000	BBP12, i7100, i5100	R4300, R7950
∞	THT-21-428	Light Grey	76.20	-	91.44 m	-	81.28	1	1	BBP12, i7100, i5100	R4300, R7950
▲	THT-55-428-1	Light Grey	101.60	50.80	-	53.98	106.68	1	1000	BBP12, i7100, i5100	R4300, R7950



B-430 Polyester material

Colour: Transparent **Finish:** Gloss

Translucent, high performance polyester material with a glossy finish. Thermal transfer printable.

Performance attributes:

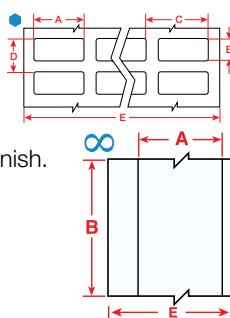

Diagram	Order Reference	Colour	Label Width A (mm)	Label Height B (mm)	Label Length B (m)	Vertical Repeat D (mm)	Web Width E (mm)	Labels per Row	Labels per Roll	Printer Compatibility	Ribbon Series
B-430 : Polyester											
●	THT-39-430-10	Transparent	25.40	12.70	–	15.88	85.09	3	10000	BBP12, i7100, i5100	R6000HF
▲	THT-17-430-3	Transparent	50.80	25.40	–	28.58	55.88	1	3000	BBP12, i7100, i5100	R6000HF
▲	THT-18-430-3	Transparent	76.20	25.40	–	28.58	81.28	1	3000	BBP12, i7100, i5100	R6000HF
▲	THT-19-430-1	Transparent	76.20	50.80	–	53.98	81.28	1	1000	BBP12, i7100, i5100	R6000HF
∞	THT-21-430	Transparent	76.20	–	91.44 m	–	81.28	1	1	BBP12, i7100, i5100	R6000HF



B-432 Polyester material

Colour: Transparent **Finish:** Gloss

Translucent, high performance polyester material with a glossy finish. Thermal transfer printable. Very similar to B-430, but has a thicker layer of acrylic adhesive for better adherence to rough surface applications.

Performance attributes:

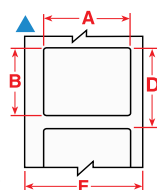

Diagram	Order Reference	Colour	Label Width A (mm)	Label Height B (mm)	Vertical Repeat D (mm)	Web Width E (mm)	Labels per Row	Labels per Roll	Printer Compatibility	Ribbon Series
B-432 : Polyester										
▲	THT-19-432-1	Transparent	76.20	50.80	53.98	81.28	1	1000	BBP12, i7100, i5100	R6000HF



B-434 Polyester material

Colour: Silver **Finish:** Gloss

Metallised polyester with a glossy finish and a thicker layer of adhesive for better adherence to rough surface applications. Withstands numerous solvents while maintaining excellent image quality.

Performance attributes:

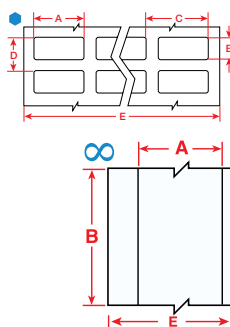

Diagram	Order Reference	Colour	Label Width A (mm)	Label Height B (mm)	Label Length B (m)	Vertical Repeat D (mm)	Web Width E (mm)	Labels per Row	Labels per Roll	Printer Compatibility	Ribbon Series
B-434A : Metallised Polyester											
●	THT-5-434-10	Silver	25.40	12.70	–	15.24	85.09	3	10000	BBP12, i7100, i5100	R6000HF
●	THT-37-434-10	Silver	38.10	12.70	–	15.24	85.09	2	10000	BBP12, i7100, i5100	R6000HF
●	THT-6-434-10	Silver	38.10	19.05	–	22.23	85.09	2	10000	BBP12, i7100, i5100	R6000HF
▲	THT-17-434-3	Silver	50.80	25.40	–	28.58	55.88	1	3000	BBP12, i7100, i5100	R6000HF
▲	THT-18-434-3	Silver	76.20	25.40	–	28.58	81.28	1	3000	BBP12, i7100, i5100	R6000HF
▲	THT-19-434-1	Silver	76.20	50.80	–	53.98	81.28	1	1000	BBP12, i7100, i5100	R6000HF
∞	THT-21-434	Silver	76.20	–	91.44 m	–	81.28	1	1	BBP12, i7100, i5100	R6000HF
▲	THT-55-434-1	Silver	101.60	50.80	–	53.98	106.68	1	1000	BBP12, i7100, i5100	R6000HF

General identification and asset tracking materials



B-435 Polyester material

Colour: Silver

Finish: Gloss

Printable metallised polyester withstands numerous solvents and variable temperatures. Ideal for serial and rating plate applications with nameplate quality and a metallic looking finish.

Performance attributes:

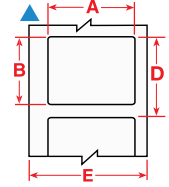
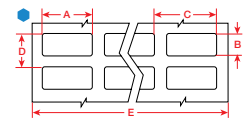

Diagram	Order Reference	Colour	Label Width A (mm)	Label Height B (mm)	Vertical Repeat D (mm)	Web Width E (mm)	Labels per Row	Labels per Roll	Printer Compatibility	Ribbon Series
B-435A : Metallised Polyester										
●	THT-12-435-10	Silver	12.70	11.10	13.64	85.09	5	10000	i7100, i5100	R6000HF
●	THT-1-435-10	Silver	19.05	6.35	8.89	85.09	4	10000	BBP12, i7100, i5100	R6000HF
●	THT-5-435-10	Silver	25.40	12.70	15.24	85.09	3	10000	BBP12, i7100, i5100	R6000HF
▲	THT-18-435-3	Silver	76.20	25.40	28.58	81.28	1	3000	BBP12, i7100, i5100	R6000HF
▲	THT-19-435-1	Silver	76.20	50.80	53.98	81.28	1	1000	BBP12, i7100, i5100	R6000HF
▲	THT-55-435-1	Silver	101.60	50.80	53.98	106.68	1	1000	BBP12, i7100, i5100	R6000HF



B-439 Vinyl material

Colour: Various

Finish: Gloss

Coloured vinyl material for thermal transfer printing. Ideal for rating plates, finished product identification, and general purpose labelling.

Performance attributes:

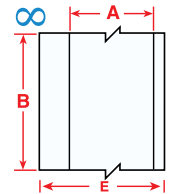

Diagram	Order Reference	Colour	Label Width A (mm)	Label Length B (m)	Web Width E (mm)	Labels per Row	Labels per Roll	Printer Compatibility	Ribbon Series
B-439 : Vinyl									
∞	BPTC-63-439-OR	Orange	63.00	40.00 m	63.00	1	1	BBP12	R6000HF
∞	BPTC-63-439-GR	Green	63.00	40.00 m	63.00	1	1	BBP12	R6000HF
∞	BPTC-63-439-BL	Blue	63.00	40.00 m	63.00	1	1	BBP12	R6000HF
∞	BPTC-63-439-YL	Yellow	63.00	40.00 m	63.00	1	1	BBP12	R6000HF
∞	BPTC-63-439-RD	Red	63.00	40.00 m	63.00	1	1	BBP12	R6000HF
∞	BPTC-63-439-SL	Silver	63.00	40.00 m	63.00	1	1	BBP12	R6000HF
∞	BPTC-63-439-BK	Black	63.00	40.00 m	63.00	1	1	BBP12	R4400
∞	BPTC-63-439-WT	White	63.00	40.00 m	63.00	1	1	BBP12	R6000HF
∞	BPTC-83-439-OR	Orange	83.00	40.00 m	83.00	1	1	BBP12	R6000HF
∞	BPTC-83-439-GR	Green	83.00	40.00 m	83.00	1	1	BBP12	R6000HF
∞	BPTC-83-439-BL	Blue	83.00	40.00 m	83.00	1	1	BBP12	R6000HF
∞	BPTC-83-439-YL	Yellow	83.00	40.00 m	83.00	1	1	BBP12	R6000HF
∞	BPTC-83-439-RD	Red	83.00	40.00 m	83.00	1	1	BBP12	R6000HF
∞	BPTC-83-439-SL	Silver	83.00	40.00 m	83.00	1	1	BBP12	R6000HF
∞	BPTC-83-439-BK	Black	83.00	40.00 m	83.00	1	1	BBP12	R4400
∞	BPTC-83-439-WT	White	83.00	40.00 m	83.00	1	1	BBP12	R6000HF
∞	BPTC-110-439-OR	Orange	110.00	40.00 m	110.00	1	1	BBP12	R6000HF
∞	BPTC-110-439-GR	Green	110.00	40.00 m	110.00	1	1	BBP12	R6000HF
∞	BPTC-110-439-BL	Blue	110.00	40.00 m	110.00	1	1	BBP12	R6000HF
∞	BPTC-110-439-YL	Yellow	110.00	40.00 m	110.00	1	1	BBP12	R6000HF
∞	BPTC-110-439-RD	Red	110.00	40.00 m	110.00	1	1	BBP12	R6000HF
∞	BPTC-110-439-SL	Silver	110.00	40.00 m	110.00	1	1	BBP12	R6000HF
∞	BPTC-110-439-BK	Black	110.00	40.00 m	110.00	1	1	BBP12	R4400
∞	BPTC-110-439-WT	White	110.00	40.00 m	110.00	1	1	BBP12	R6000HF



B-449 Polypropylene material

Colour: White

Finish: Matt

White polypropylene material stock with matt finish and removable adhesive. Used for thermal transfer printing or write-on applications. Offers excellent solvent resistance and print performance; not recommended for long-term outdoor use.

Performance attributes:

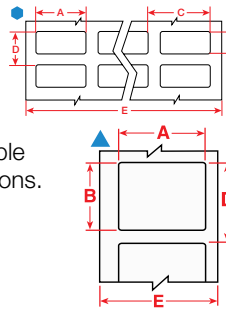

Diagram	Order Reference	Colour	Label Width A (mm)	Label Height B (mm)	Vertical Repeat D (mm)	Web Width E (mm)	Labels per Row	Labels per Roll	Printer Compatibility	Ribbon Series
B-449 : Polypropylene										
●	THT-5-449-10	White	25.40	12.70	15.24	85.09	3	10000	BBP12, i7100, i5100	R4300, R7950
●	THT-13-449-10	White	31.75	6.35	9.53	69.85	2	10000	BBP12, i7100, i5100	R4300, R7950
●	THT-6-449-3	White	38.10	19.05	22.23	85.09	2	3000	BBP12, i7100, i5100	R4300, R7950
▲	THT-17-449-1.5-SC	White	50.80	25.40	28.58	55.88	1	1500	BBP12	R7950
▲	THT-17-449-3	White	50.80	25.40	28.58	55.88	1	3000	BBP12, i7100, i5100	R4300, R7950
▲	THT-18-449-3	White	76.20	25.40	28.58	81.28	1	3000	BBP12, i7100, i5100	R4300, R7950
▲	THT-19-449-1	White	76.20	50.80	53.98	81.28	1	1	BBP12, i7100, i5100	R4300, R7950
▲	THT-55-449-1	White	101.60	50.80	53.98	106.68	1	1000	BBP12, i7100, i5100	R4300, R7950
▲	THT-76-449-1	White	101.60	76.20	79.38	106.68	1	1	BBP12, i7100, i5100	R4300, R7950



B-459 Polyester material

Colour: White

Finish: Matt

White polyester thermal transfer printable material with matt finish. Designed for applications such as topside of printed circuit boards and rating plates that utilise high quality/density alphanumeric, barcodes and graphics.

Performance attributes:

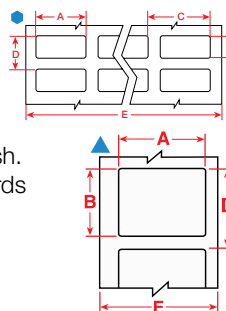

Diagram	Order Reference	Colour	Label Width A (mm)	Label Height B (mm)	Vertical Repeat D (mm)	Web Width E (mm)	Labels per Row	Labels per Roll	Printer Compatibility	Ribbon Series
B-459 : Polyester										
●	THT-14-459-10	White	16.51	5.08	7.62	74.93	4	10000	BBP12, i7100, i5100	R6000HF
●	THT-1-459-10	White	19.05	6.35	8.89	85.09	4	10000	BBP12, i7100, i5100	R6000HF
●	THT-5-459-10	White	25.40	12.70	15.24	85.09	3	10000	BBP12, i7100, i5100	R6000HF
▲	THT-19-459-1	White	76.20	50.80	53.98	81.28	1	1000	BBP12, i7100, i5100	R6000HF

General identification and asset tracking materials



B-480 Polyester material

Colour: Light Grey

Finish: Satin

Thermal transfer printable polyester material with metallic-looking finish (non-metallised) and aggressive adhesive for powder coated or rough surface applications. Ideal for barcoded asset tracking and rating plate applications.

Performance attributes:

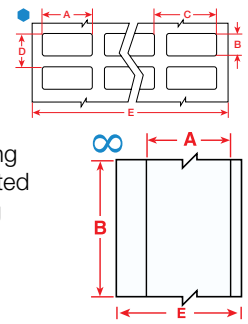

Diagram	Order Reference	Colour	Label Width A (mm)	Label Height B (mm)	Label Length B (m)	Vertical Repeat D (mm)	Web Width E (mm)	Labels per Row	Labels per Roll	Printer Compatibility	Ribbon Series
B-480A : Metallic, Non-metal Polyester											
●	THT-1-480-10	Light Grey	19.05	6.35	–	8.89	85.09	4	10000	BBP12, i7100, i5100	R6000HF
●	THT-3-480-10	Light Grey	25.40	9.53	–	12.07	85.09	3	10000	BBP12, i7100, i5100	R6000HF
●	THT-5-480-10	Light Grey	25.40	12.70	–	15.24	85.09	3	10000	BBP12, i7100, i5100	R6000HF
●	THT-37-480-10	Light Grey	38.10	12.70	–	15.24	85.09	2	10000	BBP12, i7100, i5100	R6000HF
●	THT-6-480-10	Light Grey	38.10	19.05	–	22.23	85.09	2	10000	BBP12, i7100, i5100	R6000HF
▲	THT-53-480-3	Light Grey	50.80	12.70	–	15.24	55.88	1	3000	BBP12, i7100, i5100	R6000HF
▲	THT-17-480-3	Light Grey	50.80	25.40	–	28.58	55.88	1	3000	BBP12, i7100, i5100	R6000HF
∞	THT-106-480	Light Grey	50.80	–	91.44 m	–	55.88	1	1	BBP12, i7100, i5100	R6000HF
▲	THT-7-480-3	Light Grey	69.85	31.75	–	34.93	74.93	1	3000	BBP12, i7100, i5100	R6000HF
▲	THT-18-480-3	Light Grey	76.20	25.40	–	28.58	81.28	1	3000	BBP12, i7100, i5100	R6000HF
▲	THT-19-480-1	Light Grey	76.20	50.80	–	53.98	81.28	1	1000	BBP12, i7100, i5100	R6000HF
∞	THT-21-480	Light Grey	76.20	–	91.44 m	–	81.28	1	1	BBP12, i7100, i5100	R6000HF
▲	THT-55-480-1	Light Grey	101.60	50.80	–	53.98	106.68	1	1000	BBP12, i7100, i5100	R6000HF
∞	THT-107-480	Light Grey	101.60	–	91.44 m	–	106.68	1	1	BBP12, i7100, i5100	R6000HF



B-483 Polyester material

Colour: White

Finish: Gloss

White polyester thermal transfer printable material with glossy finish and aggressive adhesive specifically designed for powder coated surfaces.

Performance attributes:

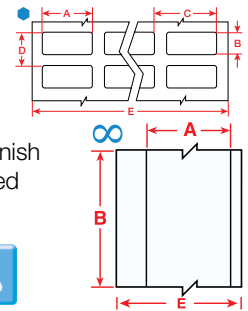

Diagram	Order Reference	Colour	Label Width A (mm)	Label Height B (mm)	Label Length B (m)	Vertical Repeat D (mm)	Web Width E (mm)	Labels per Row	Labels per Roll	Printer Compatibility	Ribbon Series
B-483A : Polyester											
▲	THT-59-483-10	White	25.40	12.70	–	15.24	30.48	1	10000	BBP12, i7100, i5100	R6000HF
●	THT-5-483-10	White	25.40	12.70	–	15.24	85.09	3	10000	BBP12, i7100, i5100	R6000HF
●	THT-37-483-10	White	38.10	12.70	–	15.24	85.09	2	10000	BBP12, i7100, i5100	R6000HF
▲	THT-17-483-3	White	50.80	25.40	–	28.58	55.88	1	3000	BBP12, i7100, i5100	R6000HF
▲	THT-7-483-3	White	69.85	31.75	–	34.93	74.93	1	3000	BBP12, i7100, i5100	R6000HF
▲	THT-18-483-3	White	76.20	25.40	–	28.58	81.28	1	3000	BBP12, i7100, i5100	R6000HF
▲	THT-19-483-1	White	76.20	50.80	–	53.98	81.28	1	1000	BBP12, i7100, i5100	R6000HF
∞	THT-21-483	White	76.20	–	91.44 m	–	81.28	1	1	BBP12, i5100	R6000HF
▲	THT-55-483-1	White	101.60	50.80	–	53.98	106.68	1	1000	BBP12, i7100, i5100	R6000HF
▲	THT-76-483-1	White	101.60	76.20	–	79.38	106.68	1	1000	BBP12, i7100, i5100	R6000HF



B-484 Polyester material

Colour: White

Finish: Gloss

White polyester thermal transfer printable material, similar to B-483, but with thinner construction for curved or angled surfaces. Offers aggressive adhesive for adhesion to textured metals and low surface energy plastics.

Performance attributes:

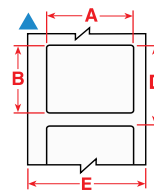
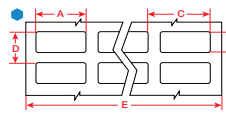

Diagram	Order Reference	Colour	Label Width A (mm)	Label Height B (mm)	Vertical Repeat D (mm)	Web Width E (mm)	Labels per Row	Labels per Roll	Printer Compatibility	Ribbon Series
B-484A : Polyester										
●	THT-5-484-10	White	25.40	12.70	15.24	85.09	3	10000	BBP12, i7100, i5100	R6000HF
▲	THT-17-484-3	White	50.80	25.40	28.58	55.88	1	3000	BBP12, i7100, i5100	R6000HF
▲	THT-18-484-3	White	76.20	25.40	28.58	81.28	1	3000	BBP12, i7100, i5100	R6000HF
▲	THT-19-484-1	White	76.20	50.80	53.98	81.28	1	1000	BBP12, i7100, i5100	R6000HF
▲	THT-55-484-1	White	101.60	50.80	53.98	106.68	1	1000	BBP12, i7100, i5100	R6000HF



B-486 Polyester material

Colour: Light Grey

Finish: Matt

Thermal transfer printable metallised polyester material. Designed for high adhesion to textured metals, powder coated surfaces and low surface energy plastics.

Performance attributes:

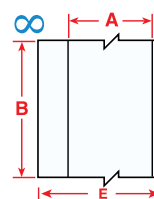
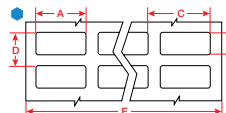

Diagram	Order Reference	Colour	Label Width A (mm)	Label Height B (mm)	Label Length B (m)	Vertical Repeat D (mm)	Web Width E (mm)	Labels per Row	Labels per Roll	Printer Compatibility	Ribbon Series
B-486B : Metallised Polyester											
▲	THT-59-486-10	Light Grey	25.40	12.70	-	15.24	30.48	1	10000	BBP12, i7100, i5100	R4300, R7950
●	THT-5-486-10	Light Grey	25.40	12.70	-	15.24	85.09	3	10000	BBP12, i7100, i5100	R4300, R7950
●	THT-37-486-10	Light Grey	38.10	12.70	-	15.24	85.09	2	10000	BBP12, i7100, i5100	R4300, R7950
●	THT-6-486-10	Light Grey	38.10	19.05	-	22.23	85.09	2	10000	BBP12, i7100, i5100	R4300, R7950
▲	THT-53-486-3	Light Grey	50.80	12.70	-	15.24	55.88	1	3000	BBP12, i7100, i5100	R4300, R7950
▲	THT-17-486-3	Light Grey	50.80	25.40	-	28.58	55.88	1	3000	BBP12, i7100, i5100	R4300, R7950
▲	THT-7-486-3	Light Grey	69.85	31.75	-	34.93	74.93	1	3000	BBP12, i7100, i5100	R4300, R7950
▲	THT-18-486-3	Light Grey	76.20	25.40	-	28.58	81.28	1	3000	BBP12, i7100, i5100	R4300, R7950
▲	THT-19-486-1	Light Grey	76.20	50.80	-	53.98	81.28	1	1000	BBP12, i7100, i5100	R4300, R7950
∞	THT-21-486	Light Grey	76.20	-	91.44 m	-	81.28	1	1	BBP12, i5100	R4300, R7950

General identification and asset tracking materials



B-488 Polyester material

Colour: White

Finish: Matt

White polyester thermal transfer printable material, similar to B-423, but with matt finish. Widely used for component identification, barcoding, asset and inventory tracking.

Performance attributes:

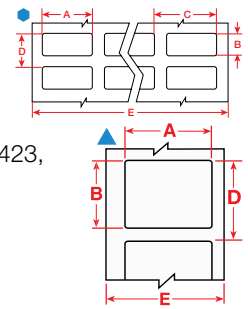

Diagram	Order Reference	Colour	Label Width A (mm)	Label Height B (mm)	Vertical Repeat D (mm)	Web Width E (mm)	Labels per Row	Labels per Roll	Printer Compatibility	Ribbon Series
B-488 : Polyester										
●	THT-14-488-10	White	16.51	5.08	7.62	74.93	4	10000	BBP12, i7100, i5100	R4300, R7950
●	THT-1-488-10	White	19.05	6.35	8.89	85.09	4	10000	BBP12, i7100, i5100	R4300, R7950
●	THT-2-488-10	White	22.86	6.35	8.89	85.09	3	10000	BBP12, i7100, i5100	R4300, R7950
●	BPT-616-488	White	22.86	19.05	21.98	80.58	3	3000	BBP12	R7950
●	THT-140-488-3	White	22.86	19.05	22.23	53.34	2	3000	BBP12, i7100, i5100	R4300, R7950
▲	THT-164-488-1	White	22.86	22.86	25.40	27.94	1	1000	BBP12, i7100, i5100	R4300, R7950
●	BPT-617-488	White	22.86	22.86	25.86	80.58	3	3000	BBP12	R7950
●	THT-141-488-3	White	22.86	22.86	25.40	53.34	2	3000	BBP12, i7100, i5100	R4300, R7950
●	THT-5-488-10	White	25.40	12.70	15.24	85.09	3	10000	BBP12, i7100, i5100	R4300, R7950
▲	BPT-635-488	White	48.26	6.35	11.35	54.26	1	2000	BBP12	R7950
▲	THT-15-488-2.5	White	50.80	6.35	9.53	55.88	1	2500	BBP12, i7100, i5100	R4300, R7950
▲	THT-17-488-3	White	50.80	25.40	28.58	55.88	1	3000	BBP12, i7100, i5100	R4300, R7950
▲	THT-18-488-3	White	76.20	25.40	28.58	81.28	1	3000	BBP12, i7100, i5100	R4300, R7950



B-489 Polyester material

Colour: White

Finish: Matt

White polyester thermal transfer printable material, similar to B-483, but with matt finish. Aggressive adhesive specifically designed for powder coated surfaces.

Performance attributes:

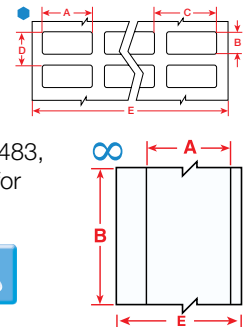

Diagram	Order Reference	Colour	Label Width A (mm)	Label Height B (mm)	Label Length B (m)	Vertical Repeat D (mm)	Web Width E (mm)	Labels per Row	Labels per Roll	Printer Compatibility	Ribbon Series
B-489A : Polyester											
●	THT-5-489-10	White	25.40	12.70	-	15.24	85.09	3	10000	BBP12, i7100, i5100	R4300, R7950
●	THT-37-489-10	White	38.10	12.70	-	15.24	85.09	2	10000	BBP12, i7100, i5100	R4300, R7950
▲	THT-17-489-3	White	50.80	25.40	-	28.58	55.88	1	3000	BBP12, i7100, i5100	R4300, R7950
▲	THT-7-489-3	White	69.85	31.75	-	34.93	74.93	1	3000	BBP12, i7100, i5100	R4300, R7950
▲	THT-18-489-3	White	76.20	25.40	-	28.58	81.28	1	3000	BBP12, i7100, i5100	R4300, R7950
▲	THT-19-489-1	White	76.20	50.80	-	53.98	81.28	1	1000	BBP12, i7100, i5100	R4300, R7950
∞	THT-21-489	White	76.20	-	91.44 m	-	81.28	1	1	BBP12, i5100	R4300, R7950
▲	THT-55-489-1	White	101.60	50.80	-	53.98	106.68	1	1000	BBP12, i7100, i5100	R4300, R7950
▲	THT-76-489-1	White	101.60	76.20	-	79.38	106.68	1	1000	BBP12, i7100, i5100	R4300, R7950



B-533 Polyester material

Colour: White

Finish: Gloss

White polyester thermal transfer material with glossy finish and removable adhesive. Ideal for electronic component marking and general purpose applications that require solvent and heat resistance and that can be cleanly removed.

Performance attributes:

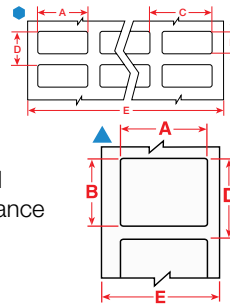

Diagram	Order Reference	Colour	Label Width A (mm)	Label Height B (mm)	Vertical Repeat D (mm)	Web Width E (mm)	Labels per Row	Labels per Roll	Printer Compatibility	Ribbon Series
B-533 : Polyester										
●	THT-12-533-10	White	12.70	11.10	13.64	85.09	5	10000	i7100, i5100	R6000HF
▲	THT-59-533-2.5-SC	White	25.40	12.70	15.24	30.48	1	2500	BBP12	R6000HF
▲	THT-59-533-10	White	25.40	12.70	15.24	30.48	1	10000	BBP12, i7100, i5100	R6000HF
●	THT-5-533-10	White	25.40	12.70	15.24	85.09	3	10000	BBP12, i7100, i5100	R6000HF
●	THT-13-533-10	White	31.75	6.35	9.53	69.85	2	10000	BBP12, i7100, i5100	R6000HF
▲	THT-17-533-3	White	50.80	25.40	28.58	55.88	1	3000	BBP12, i7100, i5100	R6000HF
▲	THT-17-533-1.5-SC	White	50.80	25.40	28.58	55.88	1	1500	BBP12	R6000HF
▲	THT-18-533-3	White	76.20	25.40	28.58	81.28	1	3000	BBP12, i7100, i5100	R6000HF
▲	THT-19-533-1	White	76.20	50.80	53.98	81.28	1	1000	BBP12, i7100, i5100	R6000HF



B-7563 Polyester material

Colour: Silver

Finish: Satin

Thermal transfer printable metallised polyester withstands numerous solvents and variable temperatures. Ideal for serial and rating plate applications with nameplate quality and a metallic finish.

Performance attributes:

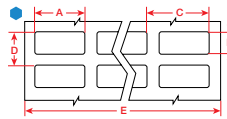

Diagram	Order Reference	Colour	Label Width A (mm)	Label Height B (mm)	Vertical Repeat D (mm)	Web Width E (mm)	Labels per Row	Labels per Roll	Printer Compatibility	Ribbon Series
B-7563 : Metallised Polyester										
●	BPT-5-7563-2.5	Silver	25.40	12.70	15.70	108.00	3	2500	BBP12	R7960
●	BPT-6-7563-2.5	Silver	38.10	19.05	22.05	108.00	2	2500	BBP12	R7960
▲	BPT-17-7563-1	Silver	50.80	25.40	28.22	108.00	1	1000	BBP12	R7960
▲	BPT-7-7563-1	Silver	69.85	31.75	34.75	108.00	1	1000	BBP12	R7960
▲	BPT-19-7563-0.5	Silver	76.00	50.00	53.00	108.00	1	500	BBP12	R7960

General identification and asset tracking materials



B-7594 Polypropylene material

Colour: Red on White **Finish: Gloss**

White polypropylene material stock with glossy finish. Used for thermal transfer printing. Offers excellent solvent resistance and print performance; not recommended for long-term outdoor use. Supplied with pre-printed red diamonds, ready for you to print the required warning, compliant to the latest regulations.

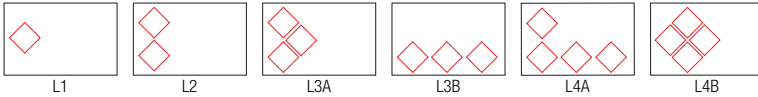
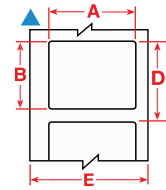

Diagram	Order Reference	Colour	Layout	Label Width A (mm)	Label Height B (mm)	Vertical Repeat D (mm)	Web Width E (mm)	Labels per Row	Labels per Roll	Printer Compatibility	Ribbon Series
B-7594 : Polypropylene											
▲	THTCLP-S-L1-7594-2	Red on White	L1	55.00	85.00	91.02	59.00	1	2000	i7100, i5100	R6000HF
▲	THTCLP-S-L2-7594-2	Red on White	L2	55.00	85.00	91.02	59.00	1	2000	i7100, i5100	R6000HF
▲	THTCLP-S-L3A-7594-2	Red on White	L3A	55.00	85.00	91.02	59.00	1	2000	i7100, i5100	R6000HF
▲	THTCLP-S-L3B-7594-2	Red on White	L3B	55.00	85.00	91.02	59.00	1	2000	i7100, i5100	R6000HF
▲	THTCLP-S-L4A-7594-2	Red on White	L4A	55.00	85.00	91.02	59.00	1	2000	i7100, i5100	R6000HF
▲	THTCLP-S-L4B-7594-2	Red on White	L4B	55.00	85.00	91.02	59.00	1	2000	i7100, i5100	R6000HF
▲	THTCLP-S-L1-7594-0.4-SC	Red on White	L1	55.00	85.00	91.02	59.00	1	400	BBP12	R6000HF
▲	THTCLP-S-L2-7594-0.4-SC	Red on White	L2	55.00	85.00	91.02	59.00	1	400	BBP12	R6000HF
▲	THTCLP-S-L3A-7594-0.4-SC	Red on White	L3A	55.00	85.00	91.02	59.00	1	400	BBP12	R6000HF
▲	THTCLP-S-L3B-7594-0.4-SC	Red on White	L3B	55.00	85.00	91.02	59.00	1	400	BBP12	R6000HF
▲	THTCLP-S-L4A-7594-0.4-SC	Red on White	L4A	55.00	85.00	91.02	59.00	1	400	BBP12	R6000HF
▲	THTCLP-S-L4B-7594-0.4-SC	Red on White	L4B	55.00	85.00	91.02	59.00	1	400	BBP12	R6000HF
▲	THTCLP-M-L1-7594-1	Red on White	L1	75.00	110.00	115.36	79.00	1	1000	i7100, i5100	R6000HF
▲	THTCLP-M-L2-7594-1	Red on White	L2	75.00	110.00	115.36	79.00	1	1000	i7100, i5100	R6000HF
▲	THTCLP-M-L3A-7594-1	Red on White	L3A	75.00	110.00	115.36	79.00	1	1000	i7100, i5100	R6000HF
▲	THTCLP-M-L3B-7594-1	Red on White	L3B	75.00	110.00	115.36	79.00	1	1000	i7100, i5100	R6000HF
▲	THTCLP-M-L4A-7594-1	Red on White	L4A	75.00	110.00	115.36	79.00	1	1000	i7100, i5100	R6000HF
▲	THTCLP-M-L4B-7594-1	Red on White	L4B	75.00	110.00	115.36	79.00	1	1000	i7100, i5100	R6000HF
▲	THTCLP-M-L1-7594-0.3-SC	Red on White	L1	75.00	110.00	115.36	79.00	1	300	BBP12	R6000HF
▲	THTCLP-M-L2-7594-0.3-SC	Red on White	L2	75.00	110.00	115.36	79.00	1	300	BBP12	R6000HF
▲	THTCLP-M-L3A-7594-0.3-SC	Red on White	L3A	75.00	110.00	115.36	79.00	1	300	BBP12	R6000HF
▲	THTCLP-M-L3B-7594-0.3-SC	Red on White	L3B	75.00	110.00	115.36	79.00	1	300	BBP12	R6000HF
▲	THTCLP-M-L4A-7594-0.3-SC	Red on White	L4A	75.00	110.00	115.36	79.00	1	300	BBP12	R6000HF
▲	THTCLP-M-L4B-7594-0.3-SC	Red on White	L4B	75.00	110.00	115.36	79.00	1	300	BBP12	R6000HF
▲	THTCLP-L-L1-7594-0.5	Red on White	L1	105.00	155.00	160.12	109.00	1	500	i7100, i5100	R6000HF
▲	THTCLP-L-L3A-7594-0.5	Red on White	L3A	105.00	155.00	160.12	109.00	1	500	i7100, i5100	R6000HF
▲	THTCLP-L-L3B-7594-0.5	Red on White	L3B	105.00	155.00	160.12	109.00	1	500	i7100, i5100	R6000HF
▲	THTCLP-L-L4B-7594-0.5	Red on White	L4B	105.00	155.00	160.12	109.00	1	500	i7100, i5100	R6000HF
▲	THTCLP-L-L1-7594-0.2-SC	Red on White	L1	105.00	155.00	160.12	109.00	1	200	BBP12	R6000HF
▲	THTCLP-L-L2-7594-0.2-SC	Red on White	L2	105.00	155.00	160.12	109.00	1	200	BBP12	R6000HF
▲	THTCLP-L-L3A-7594-0.2-SC	Red on White	L3A	105.00	155.00	160.12	109.00	1	200	BBP12	R6000HF
▲	THTCLP-L-L3B-7594-0.2-SC	Red on White	L3B	105.00	155.00	160.12	109.00	1	200	BBP12	R6000HF
▲	THTCLP-L-L4B-7594-0.2-SC	Red on White	L4B	105.00	155.00	160.12	109.00	1	200	BBP12	R6000HF

B-7604 Paper material

Colour: White

Finish: Matt

White direct thermal paper material for standard performance general labelling applications.

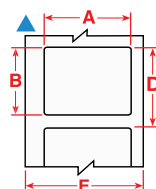

Diagram	Order Reference	Colour	Label Width A (mm)	Label Height B (mm)	Vertical Repeat D (mm)	Web Width E (mm)	Labels per Row	Labels per Roll	Printer Compatibility
B-7604 : Direct Thermal Paper									
▲	BPT-999-007	White	30.48	21.60	24.60	34.00	1	18000	BBP12
▲	BPT-512-105	White	31.75	25.40	28.40	35.00	1	16560	BBP12
▲	BPT-522-075	White	57.15	19.05	22.23	59.94	1	21360	BBP12
▲	BPT-522-125	White	57.15	31.75	34.93	59.94	1	13620	BBP12
▲	BPT-522-205	White	57.15	50.80	53.98	59.94	1	8820	BBP12
▲	BPT-522-305	White	57.15	76.20	79.38	59.94	1	6000	BBP12
▲	BPT-522-405	White	57.15	101.60	104.78	59.94	1	4560	BBP12
▲	BPT-540-105	White	101.60	25.40	28.58	107.95	1	15720	BBP12
▲	BPT-540-155	White	101.60	38.10	41.28	107.95	1	11520	BBP12
▲	BPT-540-250	White	101.60	63.50	66.68	107.95	1	7680	BBP12
▲	BPT-540-305	White	101.60	76.20	79.38	107.95	1	6000	BBP12
▲	BPT-540-405	White	101.60	101.60	104.78	107.95	1	4560	BBP12
▲	BPT-540-500	White	101.60	127.00	130.18	107.95	1	3660	BBP12
▲	BPT-540-600	White	101.60	152.40	155.58	107.95	1	3000	BBP12

B-7606 Paper material

Colour: White

Finish: Gloss

White thermal transfer printable paper for standard performance general labelling applications.

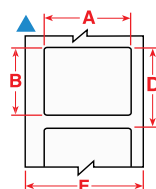

Diagram	Order Reference	Colour	Label Width A (mm)	Label Height B (mm)	Vertical Repeat D (mm)	Web Width E (mm)	Labels per Row	Labels per Roll	Printer Compatibility	Ribbon Series
B-7606 : Paper										
▲	BPT-722-075	White	57.15	19.05	22.23	59.94	1	21360	BBP12	R7940
▲	BPT-222-125	White	57.15	31.75	34.93	59.94	1	13620	BBP12	R7940
▲	BPT-222-205	White	57.15	50.80	53.98	59.94	1	8820	BBP12	R7940
▲	BPT-222-305	White	57.15	76.20	79.38	59.94	1	6000	BBP12	R7940
▲	BPT-222-405	White	57.15	101.60	104.78	59.94	1	4560	BBP12	R7940
▲	BPT-740-155	White	101.60	38.10	41.28	107.95	1	11520	BBP12	R7940
▲	BPT-240-305	White	101.60	76.20	79.38	107.95	1	6000	BBP12	R7940
▲	BPT-240-405	White	101.60	101.60	104.78	107.95	1	4560	BBP12	R7940
▲	BPT-740-505	White	101.60	127.00	130.18	107.95	1	3660	BBP12	R7940
▲	BPT-240-605	White	101.60	152.40	155.58	107.95	1	3000	BBP12	R7940

General identification and asset tracking materials



B-7610 Paper material

Colour: Red on White **Finish: Matt**

White thermal transfer printable paper for standard performance general labelling applications. Supplied with pre-printed red diamonds, ready for you to print the required warning, compliant to the latest regulations.

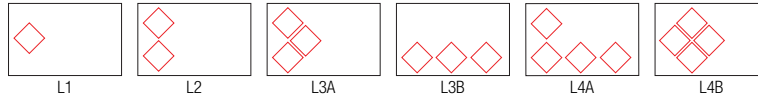
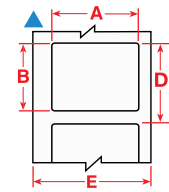

Diagram	Order Reference	Colour	Layout	Label Width A (mm)	Label Height B (mm)	Vertical Repeat D (mm)	Web Width E (mm)	Labels per Row	Labels per Roll	Printer Compatibility	Ribbon Series
B-7610 : Paper											
▲	THTCLP-S-L2-7610-2	Red on White	L2	55.00	85.00	91.02	59.00	1	2000	i7100, i5100	R7950
▲	THTCLP-S-L3B-7610-2	Red on White	L3B	55.00	85.00	91.02	59.00	1	2000	i7100, i5100	R7950
▲	THTCLP-S-L4B-7610-2	Red on White	L4B	55.00	85.00	91.02	59.00	1	2000	i7100, i5100	R7950
▲	THTCLP-S-L1-7610-0.4-SC	Red on White	L1	55.00	85.00	91.02	59.00	1	400	BBP12	R7950
▲	THTCLP-S-L3A-7610-0.4-SC	Red on White	L3A	55.00	85.00	91.02	59.00	1	400	BBP12	R7950
▲	THTCLP-S-L4A-7610-0.4-SC	Red on White	L4A	55.00	85.00	91.02	59.00	1	400	BBP12	R7950
▲	THTCLP-S-L4B-7610-0.4-SC	Red on White	L4B	55.00	85.00	91.02	59.00	1	400	BBP12	R7950
▲	THTCLP-M-L2-7610-1	Red on White	L2	75.00	110.00	115.36	79.00	1	1000	i7100, i5100	R7950
▲	THTCLP-M-L3A-7610-1	Red on White	L3A	75.00	110.00	115.36	79.00	1	1000	i7100, i5100	R7950
▲	THTCLP-M-L3B-7610-1	Red on White	L3B	75.00	110.00	115.36	79.00	1	1000	i7100, i5100	R7950
▲	THTCLP-M-L4B-7610-1	Red on White	L4B	75.00	110.00	115.36	79.00	1	1000	i7100, i5100	R7950
▲	THTCLP-M-L3A-7610-0.3-SC	Red on White	L3A	75.00	110.00	115.36	79.00	1	300	BBP12	R7950
▲	THTCLP-M-L4B-7610-0.3-SC	Red on White	L4B	75.00	110.00	115.36	79.00	1	300	BBP12	R7950
▲	THTCLP-L-L2-7610-0.5	Red on White	L2	105.00	155.00	160.12	109.00	1	500	i7100, i5100	R7950
▲	THTCLP-L-L3A-7610-0.5	Red on White	L3A	105.00	155.00	160.12	109.00	1	500	i7100, i5100	R7950
▲	THTCLP-L-L3B-7610-0.5	Red on White	L3B	105.00	155.00	160.12	109.00	1	500	i7100, i5100	R7950
▲	THTCLP-L-L4A-7610-0.5	Red on White	L4A	105.00	155.00	160.12	109.00	1	500	i7100, i5100	R7950
▲	THTCLP-L-L2-7610-0.2-SC	Red on White	L2	105.00	155.00	160.12	109.00	1	200	BBP12	R7950
▲	THTCLP-L-L3A-7610-0.2-SC	Red on White	L3A	105.00	155.00	160.12	109.00	1	200	BBP12	R7950
▲	THTCLP-L-L3B-7610-0.2-SC	Red on White	L3B	105.00	155.00	160.12	109.00	1	200	BBP12	R7950



B-8117 Polyester material

Colour: Black **Finish: Matt**

The black label shows excellent print durability versus abrasion and fluids and offers great barcode readability. It resists low and high temperatures, UV and humidity.

Performance attributes:

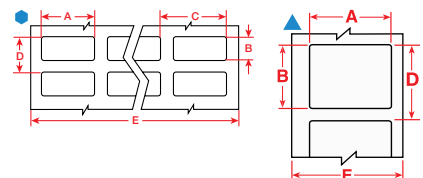

Diagram	Order Reference	Colour	Label Width A (mm)	Label Height B (mm)	Vertical Repeat D (mm)	Web Width E (mm)	Labels per Row	Labels per Roll	Printer Compatibility	Ribbon Series
B-8117 : Polyester										
●	THT-5-8117-10	Black	25.40	12.70	15.88	85.09	3	10000	BBP12, i7100, i5100	R4400W, R6800
●	THT-6-8117-10	Black	38.10	19.05	22.23	85.09	2	10000	BBP12, i7100, i5100	R4400W, R6800
▲	THT-17-8117-3	Black	50.80	25.40	28.58	55.88	1	3000	BBP12, i7100, i5100	R4400W, R6800
▲	THT-18-8117-3	Black	76.20	25.40	28.58	81.28	1	3000	BBP12, i7100, i5100	R4400W, R6800
▲	THT-19-8117-1	Black	76.20	50.80	53.98	81.28	1	1000	BBP12, i7100, i5100	R4400W, R6800

B-8423 Polyester material

Colour: White, Yellow **Finish:** Satin

Polyester material with satin finish, alternative to B-423. Used for component identification, barcoding, asset and inventory tracking.

Performance attributes:

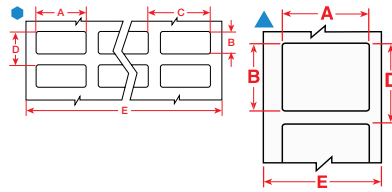

Diagram	Order Reference	Colour	Label Width A (mm)	Label Height B (mm)	Vertical Repeat D (mm)	Web Width E (mm)	Labels per Row	Labels per Roll	Printer Compatibility	Ribbon Series
B-8423 : Polyester										
●	BPT-11-8423-2.5	White	6.35	6.35	9.35	108.00	15	2500	BBP12	R6000HF
●	BPT-38-8423-2.5	White	9.53	9.53	12.53	108.00	9	2500	BBP12	R6000HF
●	BPT-12-8423-2.5	White	12.70	11.10	14.13	108.00	7	2500	BBP12	R6000HF
●	BPT-G3-8423-YL	Yellow	15.00	9.00	17.00	108.00	5	2500	BBP12	R7961
●	BPT-14-8423-2.5	White	16.51	5.08	8.08	108.00	5	2500	BBP12	R6000HF
●	BPT-1-8423-2.5	White	19.05	6.35	9.35	108.00	5	2500	BBP12	R6000HF
●	THT-G2-8423-YL	Yellow	20.00	7.95	15.00	108.00	4	10000	BBP12, i7100, i5100	R6000HF
●	BPT-G2-8423-YL	Yellow	20.00	7.95	15.00	108.00	4	5000	BBP12	R7961
●	BPT-5-8423-2.5	White	25.40	12.70	15.70	108.00	3	2500	BBP12	R6000HF
●	BPT-13-8423-2.5	White	31.75	6.35	9.35	108.00	3	2500	BBP12	R6000HF
●	BPT-4-8423-2.5	White	38.10	6.35	9.35	108.00	2	2500	BBP12	R6000HF
●	BPT-6-8423-2.5	White	38.10	19.05	22.05	108.00	2	2500	BBP12	R6000HF
▲	XTHT-17-8423-5	White	50.80	25.40	28.58	55.88	1	5000	BBP12, i7100, i5100	R6000HF
▲	BPT-17-8423-1	White	50.80	25.40	28.22	108.00	1	1000	BBP12	R6000HF
▲	BPT-7-8423-1	White	69.85	31.75	34.75	108.00	1	1000	BBP12	R6000HF
▲	XTHT-18-8423-5	White	76.20	25.40	28.58	81.28	1	5000	BBP12, i7100, i5100	R6000HF
▲	XTHT-19-8423-3	White	76.20	50.80	53.98	81.28	1	3000	BBP12, i7100, i5100	R6000HF
▲	XTHT-55-8423-3	White	101.60	50.80	53.98	106.68	1	3000	BBP12, i7100, i5100	R6000HF



B-8591 Polymer material

Colour: White, Silver, Yellow, Black **Finish:** Gloss

The toughest outdoor identification label lasts up to 12 years outdoors without an overlamine. It is ideal to barcode and to identify solar panels, vehicles, equipment and facilities or exposed cables.

Performance attributes:

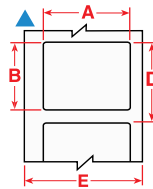
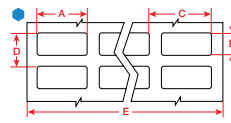

Diagram	Order Reference	Colour	Label Width A (mm)	Label Height B (mm)	Vertical Repeat D (mm)	Web Width E (mm)	Labels per Row	Labels per Roll	Printer Compatibility	Ribbon Series
B-8591 : Polyester										
●	THT-5-8591-10-WT	White	25.40	12.70	15.88	85.09	3	10000	BBP12, i7100, i5100	R6600
●	THT-5-8591-10-SL	Silver	25.40	12.70	15.88	85.09	3	10000	BBP12, i7100, i5100	R6600
●	THT-5-8591-10-YL	Yellow	25.40	12.70	15.88	85.09	3	10000	BBP12, i7100, i5100	R6600
●	THT-5-8591-10-BK	Black	25.40	12.70	15.88	85.09	3	10000	BBP12, i7100, i5100	R4400-WT
●	THT-6-8591-10-WT	White	38.10	19.05	22.23	85.09	2	10000	BBP12, i7100, i5100	R6600
●	THT-6-8591-10-SL	Silver	38.10	19.05	22.23	85.09	2	10000	BBP12, i7100, i5100	R6600
●	THT-6-8591-10-YL	Yellow	38.10	19.05	22.23	85.09	2	10000	BBP12, i7100, i5100	R6600
●	THT-6-8591-10-BK	Black	38.10	19.05	22.23	85.09	2	10000	BBP12, i7100, i5100	R4400-WT
▲	THT-17-8591-3-WT	White	50.80	25.40	28.58	55.88	1	3000	BBP12, i7100, i5100	R6600
▲	THT-17-8591-3-SL	Silver	50.80	25.40	28.58	55.88	1	3000	BBP12, i7100, i5100	R6600
▲	THT-17-8591-3-YL	Yellow	50.80	25.40	28.58	55.88	1	3000	BBP12, i7100, i5100	R6600
▲	THT-17-8591-3-BK	Black	50.80	25.40	28.58	55.88	1	3000	BBP12, i7100, i5100	R4400-WT
▲	THT-18-8591-3-WT	White	76.20	25.40	28.58	81.28	1	3000	BBP12, i7100, i5100	R6600
▲	THT-18-8591-3-SL	Silver	76.20	25.40	28.58	81.28	1	3000	BBP12, i7100, i5100	R6600
▲	THT-18-8591-3-YL	Yellow	76.20	25.40	28.58	81.28	1	3000	BBP12, i7100, i5100	R6600
▲	THT-18-8591-3-BK	Black	76.20	25.40	28.58	81.28	1	3000	BBP12, i7100, i5100	R4400-WT
▲	THT-19-8591-1-WT	White	76.20	50.80	53.98	81.28	1	1000	BBP12, i7100, i5100	R6600
▲	THT-19-8591-1-SL	Silver	76.20	50.80	53.98	81.28	1	1000	BBP12, i7100, i5100	R6600
▲	THT-19-8591-1-YL	Yellow	76.20	50.80	53.98	81.28	1	1000	BBP12, i7100, i5100	R6600
▲	THT-19-8591-1-BK	Black	76.20	50.80	53.98	81.28	1	1000	BBP12, i7100, i5100	R4400-WT

Overlaminating materials



B-103 Overlaminating material

Colour: Transparent **Finish: Gloss**

Clear polyester overlaminating labels recommended for use with most Brady materials. Place label on top of printed materials to protect against dirt, chemicals and abrasion.

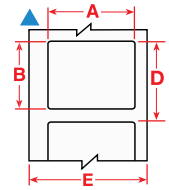

Performance attributes:



Diagram	Order Reference	Colour	Label Width A (mm)	Label Height B (mm)	Vertical Repeat D (mm)	Web Width E (mm)	Labels per Row	Labels per Roll
B-103 : Polyester Overlaminate								
▲	LAM-1-103	Transparent	16.51	5.08	6.65	21.59	1	5000
▲	LAM-2-103	Transparent	25.40	6.35	7.92	30.48	1	5000
▲	LAM-5-103	Transparent	25.40	12.70	14.27	30.48	1	2000
▲	LAM-3-103	Transparent	38.10	6.35	7.92	43.18	1	5000
▲	LAM-6-103	Transparent	38.10	19.05	20.62	43.18	1	2000
▲	LAM-7-103	Transparent	50.80	25.40	26.97	55.88	1	2000



B-423 Polyester material with B-966B overlaminate

Colour: White **Finish: Gloss**

PermaShield Labels: A white polyester label that comes with a separate overlaminate to be applied over the label once printed. This way the label remains clear and easy-to-read, even in harsh environments. Overlaminate is a clear polyester (B-966B) that extends outside of label on each side when applied.

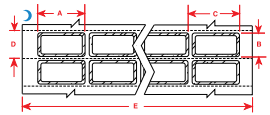

Diagram	Order Reference	Colour	Label Width A (mm)	Label Height B (mm)	Vertical Repeat D (mm)	Web Width E (mm)	Labels per Row	Labels per Roll	Printer Compatibility	Ribbon Series
B-423/B-966B : Polyester with Polyester Overlaminate										
☺	THT-22-423-2	White	31.75	19.05	28.58	85.09	2	2000	BBP12, i7100, i5100	R6000HF
☺	THT-23-423-2	White	50.80	25.40	34.93	62.23	1	2000	BBP12, i7100, i5100	R6000HF
☺	THT-24-423-1	White	69.85	44.45	53.98	81.28	1	1000	BBP12, i7100, i5100	R6000HF



B-428 Polyester material with B-966B overlaminate

Colour: Silver **Finish: Gloss**

PermaShield Labels: A metallised polyester label that comes with a separate overlaminate to be applied over the label once printed. This way the label remains clear and easy-to-read, even in harsh environments. Overlaminate is a clear polyester (B-966B) that extends outside of label on each side when applied.

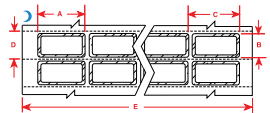

Diagram	Order Reference	Colour	Label Width A (mm)	Label Height B (mm)	Vertical Repeat D (mm)	Web Width E (mm)	Labels per Row	Labels per Roll	Printer Compatibility	Ribbon Series
B-428/B-966B : Metallised Polyester with Polyester Overlaminate										
☺	THT-22-428-2	Silver	31.75	19.05	28.58	85.09	2	2000	BBP12, i7100, i5100	R4300, R7950
☺	THT-23-428-2	Light Grey	50.80	25.40	34.93	62.23	1	2000	BBP12, i7100, i5100	R4300, R7950
☺	THT-24-428-1	Light Grey	69.85	44.45	53.98	81.28	1	1000	BBP12, i7100, i5100	R4300, R7950

B-434 Polyester material with B-7564 overlaminate

Colour: Silver

Finish: Gloss

Metallised polyester with a thicker layer of adhesive for better adherence to rough surface applications. Comes with a separate overlaminate (B-7564). This Print & Protect construction allows extremely quick, easy and 100% accurate laminating of a transparent laminate on top of a printed label.

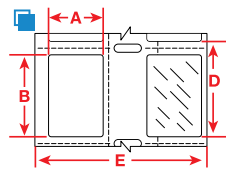

Diagram	Order Reference	Colour	Label Width A (mm)	Label Height B (mm)	Vertical Repeat D (mm)	Web Width E (mm)	Labels per Row	Labels per Roll	Printer Compatibility	Ribbon Series
B-434/B-7564 : Metallised Polyester with Polyester Overlaminate										
	THTPNP-01-434/7564-2	Silver	20.00	30.00	34.93	63.00	1	2000	BBP12, i7100, i5100	R4900, R6000HF
	THTPNP-02-434/7564-1	Silver	25.40	50.80	55.88	75.60	1	1000	BBP12, i7100, i5100	R4900, R6000HF
	THTPNP-03-434/7564-1	Silver	50.00	75.00	80.17	114.00	1	1000	BBP12, i7100, i5100	R4900, R6000HF

B-483 Polyester material with B-7552 overlaminate

Colour: White

Finish: Gloss

White polyester with glossy finish and aggressive adhesive specifically designed for powder coated surfaces. Comes with a separate overlaminate (B-7552). This Print & Protect construction allows extremely quick, easy and 100% accurate laminating of a transparent laminate on top of a printed label.

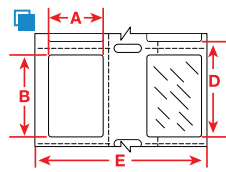

Diagram	Order Reference	Colour	Label Width A (mm)	Label Height B (mm)	Vertical Repeat D (mm)	Web Width E (mm)	Labels per Row	Labels per Roll	Printer Compatibility	Ribbon Series
B-483A/B-7552 : Polyester with Polyester Overlaminate										
	THTPNP-01-483/7552-2	White	20.00	30.00	34.93	63.00	1	2000	BBP12, i7100, i5100	R4900, R6000HF
	THTPNP-02-483/7552-1	White	25.40	50.80	55.88	75.60	1	1000	BBP12, i7100, i5100	R4900, R6000HF
	THTPNP-03-483/7552-1	White	50.00	75.00	80.17	114.00	1	1000	BBP12, i7100, i5100	R4900, R6000HF

B-7593 EPREP Polyester material - Rectangular

Colour: Various

Finish: Gloss

Thermal transfer printable raised panel labels. Designed to make legend plate creation quick, less expensive, and hassle free! Use for electrical components, electrical cabinets, push buttons, patch panels, and any other applications you can imagine. This material can also be used for rating and serial plates using alphanumeric that require name plate quality. Available in a variety of colours.

Performance attributes:

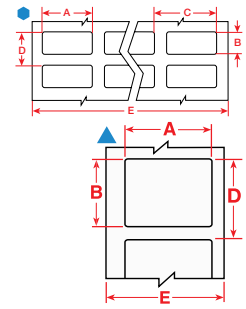

Diagram	Order Reference	Colour	Label Width A (mm)	Label Height B (mm)	Vertical Repeat D (mm)	Web Width E (mm)	Labels per Row	Labels per Roll	Printer Compatibility	Ribbon Series
B-7593 : Polyethylene Foam Laminate Polyester										
●	THTEP-20-7593-WT	White	8.00	125.00	135.00	85.09	7	2800	i7100	R6000HF
▲	THTEP-01-7593-WT	White	27.00	7.95	11.04	37.00	1	2500	i7100	R6000HF
▲	THTEP-01-7593-SV	Silver	27.00	7.95	11.04	37.00	1	2500	i7100	R6000HF
▲	THTEP-01-7593-BK	Black	27.00	7.95	11.04	37.00	1	2500	i7100	R4400-WT
▲	THTEP-02-7593-WT	White	27.00	12.45	15.88	37.00	1	2000	i7100	R6000HF
▲	THTEP-02-7593-SV	Silver	27.00	12.45	15.88	37.00	1	2000	i7100	R6000HF
▲	THTEP-02-7593-BK	Black	27.00	12.45	15.88	37.00	1	2000	i7100	R4400-WT
▲	THTEP-03-7593-WT	White	27.00	15.00	18.14	37.00	1	1500	i7100	R6000HF
▲	THTEP-03-7593-SV	Silver	27.00	15.00	18.14	37.00	1	1500	i7100	R6000HF
▲	THTEP-03-7593-BK	Black	27.00	15.00	18.14	37.00	1	1500	i7100	R4400-WT
▲	THTEP-04-7593-WT	White	27.00	18.00	21.16	37.00	1	1500	i7100	R6000HF
▲	THTEP-04-7593-SV	Silver	27.00	18.00	21.16	37.00	1	1500	i7100	R6000HF
▲	THTEP-04-7593-BK	Black	27.00	18.00	21.16	37.00	1	1500	i7100	R4400-WT
▲	THTEP-07-7593-WT	White	35.00	18.00	21.00	45.00	1	1250	i7100	R6000HF
▲	THTEP-07-7593-SV	Silver	35.00	18.00	21.00	45.00	1	1250	i7100	R6000HF
▲	THTEP-07-7593-BK	Black	35.00	18.00	21.00	45.00	1	1250	i7100	R4400-WT
▲	THTEP-07-7593-YL	Yellow	35.00	18.00	21.00	45.00	1	1250	i7100	R6000HF
▲	THTEP-06-7593-WT	White	45.00	15.00	18.86	55.00	1	1500	i7100	R6000HF
▲	THTEP-06-7593-SV	Silver	45.00	15.00	18.86	55.00	1	1500	i7100	R6000HF
▲	THTEP-06-7593-BK	Black	45.00	15.00	18.86	55.00	1	1500	i7100	R4400-WT
▲	THTEP-08-7593-WT	White	48.00	19.00	21.96	58.00	1	1250	i7100	R6000HF
▲	THTEP-08-7593-SV	Silver	48.00	19.00	21.96	58.00	1	1250	i7100	R6000HF
▲	THTEP-08-7593-BK	Black	48.00	19.00	21.96	58.00	1	1250	i7100	R4400-WT
▲	THTEP-08-7593-YL	Yellow	48.00	19.00	21.96	58.00	1	1250	i7100	R6000HF
▲	THTEP-15-7593-WT	White	60.00	30.00	32.94	70.00	1	750	i7100	R6000HF
▲	THTEP-15-7593-SV	Silver	60.00	30.00	32.94	70.00	1	750	i7100	R6000HF
▲	THTEP-15-7593-BK	Black	60.00	30.00	32.94	70.00	1	750	i7100	R4400-WT
▲	THTEP-15-7593-YL	Yellow	60.00	30.00	32.94	70.00	1	750	i7100	R6000HF
▲	THTEP-18-7593-SV	Silver	60.00	400.00	412.75	70.00	1	200	i7100	R6000HF
▲	THTEP-18-7593-WT	White	60.00	400.00	412.75	70.00	1	200	i7100	R6000HF
▲	THTEP-09-7593-WT	White	69.00	19.00	21.96	79.00	1	1200	i7100	R6000HF
▲	THTEP-09-7593-SV	Silver	69.00	19.00	21.96	79.00	1	1200	i7100	R6000HF
▲	THTEP-09-7593-BK	Black	69.00	19.00	21.96	79.00	1	1200	i7100	R4400-WT
▲	THTEP-09-7593-YL	Yellow	69.00	19.00	21.96	79.00	1	1200	i7100	R6000HF
▲	THTEP-17-7593-SV	Silver	69.00	150.00	161.92	79.00	1	400	i7100	R6000HF
▲	THTEP-17-7593-WT	White	69.00	150.00	161.92	79.00	1	400	i7100	R6000HF
▲	THTEP-21-7593-WT	White	75.00	25.00	28.22	81.00	1	500	i7100	R6000HF
▲	THTEP-21-7593-YL	Yellow	75.00	25.00	28.22	81.00	1	500	i7100	R6000HF
▲	THTEP-16-7593-WT	White	90.00	45.00	47.62	100.00	1	500	i7100	R6000HF
▲	THTEP-16-7593-SV	Silver	90.00	45.00	47.62	100.00	1	500	i7100	R6000HF
▲	THTEP-16-7593-BK	Black	90.00	45.00	47.62	100.00	1	500	i7100	R4400-WT
▲	THTEP-16-7593-YL	Yellow	90.00	45.00	47.62	100.00	1	500	i7100	R6000HF
▲	THTEP-22-7593-WT	White	100.00	25.00	28.22	106.00	1	500	i7100	R6000HF
▲	THTEP-22-7593-YL	Yellow	100.00	25.00	28.22	106.00	1	500	i7100	R6000HF
▲	THTEP-11-7593-WT	White	100.00	30.00	32.94	110.00	1	500	i7100	R6000HF
▲	THTEP-11-7593-SV	Silver	100.00	30.00	32.94	110.00	1	500	i7100	R6000HF
▲	THTEP-11-7593-BK	Black	100.00	30.00	32.94	110.00	1	500	i7100	R4400-WT
▲	THTEP-11-7593-YL	Yellow	100.00	30.00	32.94	110.00	1	500	i7100	R6000HF
▲	THTEP-12-7593-WT	White	100.00	50.00	52.70	110.00	1	500	i7100	R6000HF
▲	THTEP-12-7593-SV	Silver	100.00	50.00	52.70	110.00	1	500	i7100	R6000HF
▲	THTEP-12-7593-BK	Black	100.00	50.00	52.70	110.00	1	500	i7100	R4400-WT
▲	THTEP-12-7593-YL	Yellow	100.00	50.00	52.70	110.00	1	500	i7100	R6000HF

B-7593 EPREP Polyester material - Push button

Colour: Various

Finish: Gloss

Thermal transfer printable raised panel labels. Designed to make legend plate creation quick, less expensive, and hassle free! Use for electrical components, electrical cabinets, push buttons, patch panels, and any other applications you can imagine. This material can also be used for rating and serial plates using alphanumeric that require name plate quality. Available in a variety of colours.

Performance attributes:

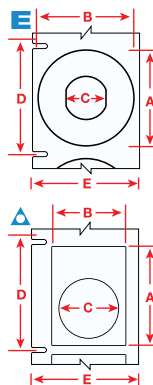
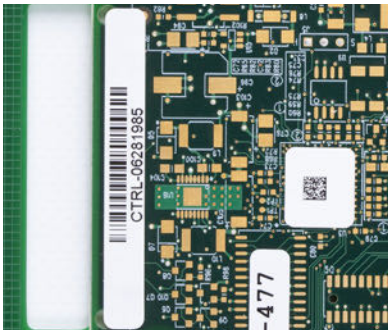

Diagram	Order Reference	Colour	Label Width A (mm)	Label Height B (mm)	Hole Diameter C (mm)	Vertical Repeat D (mm)	Web Width E (mm)	Labels per Row	Labels per Roll	Printer Compatibility	Ribbon Series
B-7593 : Polyethylene Foam Laminate Polyester											
△	THTEP-05-7593-RD	Red	30.00	40.00	24.00 mm	43.39	43.00	1	750	i7100	R6000HF
△	THTEP-05-7593-GN	Green	30.00	40.00	24.00 mm	43.39	43.00	1	750	i7100	R6000HF
△	THTEP-05-7593-BK	Black	30.00	40.00	24.00 mm	43.39	43.00	1	750	i7100	R4400-WT
△	THTEP-05-7593-WT	White	30.00	40.00	24.00 mm	43.39	43.00	1	750	i7100	R6000HF
△	THTEP-05-7593-SV	Silver	30.00	40.00	24.00 mm	43.39	43.00	1	750	i7100	R6000HF
E	THTEP-19-7593-YL	Yellow	60.00	60.00	25.00 mm	69.85	73.00	1	100	i7100	R6000HF
E	THTEP-19-7593-RD	Red	60.00	60.00	25.00 mm	69.85	73.00	1	100	i7100	R6000HF



B-473 Electrostatic dissipative polyester material

Colour: White

Finish: Gloss

White polyester with glossy finish used for printed circuit board and electronic component post-process labelling. Surface resistivity values in the recommended range for dissipative ESD packing materials.

Performance attributes:

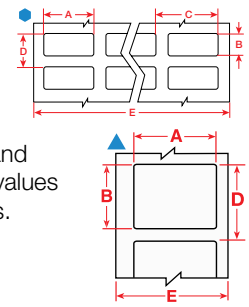
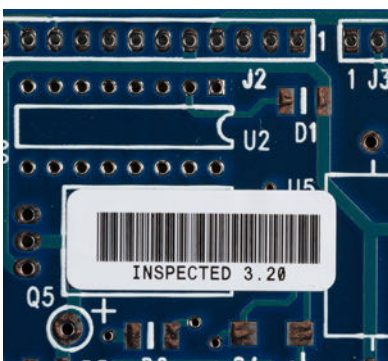

Diagram	Order Reference	Colour	Label Width A (mm)	Label Height B (mm)	Vertical Repeat D (mm)	Web Width E (mm)	Labels per Row	Labels per Roll	Printer Compatibility	Ribbon Series
B-473 : Static Dissipative Polyester										
●	THT-11-473-10	White	6.35	6.35	9.53	81.28	12	10000	BBP12, i7100, i5100	R6000HF
●	THT-70-473-20	White	6.35	6.35	8.89	60.20	7	20000	BBP12, i7100, i5100	R6000HF
●	THT-38-473-10	White	9.53	9.53	12.07	81.28	7	10000	BBP12, i7100, i5100	R6000HF
●	THT-36-473-10	White	12.70	5.08	7.62	81.28	5	10000	BBP12, i7100, i5100	R6000HF
▲	THT-97-473-10	White	12.70	5.08	7.62	17.78	1	10000	BBP12, i7100, i5100	R6000HF
●	THT-96-473-10	White	12.70	6.99	9.53	63.50	4	10000	BBP12, i7100, i5100	R6000HF
●	THT-12-473-10	White	12.70	11.10	13.64	85.09	5	10000	i7100, i5100	R6000HF
▲	THT-99-473-10	White	12.70	12.70	15.24	17.78	1	10000	BBP12, i7100, i5100	R6000HF
●	THT-14-473-10	White	16.51	5.08	7.62	74.93	4	10000	BBP12, i7100, i5100	R6000HF
▲	THT-47-473-10	White	16.51	5.08	7.62	21.59	1	10000	BBP12, i7100, i5100	R6000HF
●	THT-57-473-10	White	17.78	9.53	12.07	85.09	4	10000	BBP12, i7100, i5100	R6000HF
●	THT-1-473-10	White	19.05	6.35	8.89	85.09	4	10000	BBP12, i7100, i5100	R6000HF
▲	THT-46-473-10	White	19.05	6.35	8.89	24.13	1	10000	BBP12, i7100, i5100	R6000HF
●	THT-2-473-10	White	22.86	6.35	8.89	85.09	3	10000	BBP12, i7100, i5100	R6000HF
▲	THT-49-473-10	White	22.86	6.35	8.89	27.94	1	10000	BBP12, i7100, i5100	R6000HF
●	THT-3-473-10	White	25.40	9.53	12.07	85.09	3	10000	BBP12, i7100, i5100	R6000HF
▲	THT-58-473-10	White	25.40	9.53	12.07	30.48	1	10000	BBP12, i7100, i5100	R6000HF
▲	THT-59-473-10	White	25.40	12.70	15.24	30.48	1	10000	BBP12, i7100, i5100	R6000HF
●	THT-5-473-10	White	25.40	12.70	15.24	85.09	3	10000	BBP12, i7100, i5100	R6000HF
●	THT-13-473-10	White	31.75	6.35	9.53	69.85	2	10000	BBP12, i7100, i5100	R6000HF
▲	THT-43-473-10	White	31.75	6.35	8.89	36.83	1	10000	BBP12, i7100, i5100	R6000HF
●	THT-4-473-10	White	38.10	6.35	8.89	85.09	2	10000	BBP12, i7100, i5100	R6000HF
▲	THT-45-473-10	White	38.10	6.35	8.89	43.18	1	10000	BBP12, i7100, i5100	R6000HF
▲	THT-15-473-2.5	White	50.80	6.35	9.53	55.88	1	2500	BBP12, i7100, i5100	R6000HF
▲	THT-48-473-10	White	50.80	6.35	8.89	55.88	1	10000	BBP12, i7100, i5100	R6000HF



B-717 Electrostatic dissipative polyimide material

Colour: White

Finish: Gloss

White polyimide material with glossy finish and ultra-durable adhesive. Used in printed circuit board and electronic component pre-process labelling. Designed for use with extreme wash protocol and cleaning chemicals. Surface resistivity values in the recommended range for dissipative ESD packing materials.

Performance attributes:

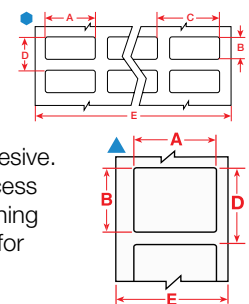

Diagram	Order Reference	Colour	Label Width A (mm)	Label Height B (mm)	Vertical Repeat D (mm)	Web Width E (mm)	Labels per Row	Labels per Roll	Printer Compatibility	Ribbon Series
B-717 : Polyimide										
●	THT-70-717-20	White	6.35	6.35	8.89	60.20	7	20000	BBP12, i7100, i5100	R6000HF
●	THT-38-717-10	White	9.53	9.53	12.07	81.28	7	10000	BBP12, i7100, i5100	R6000HF
▲	THT-97-717-10	White	12.70	5.08	7.62	17.78	1	10000	BBP12, i7100, i5100	R6000HF
●	THT-96-717-10	White	12.70	6.99	9.53	63.50	4	10000	BBP12, i7100, i5100	R6000HF
●	THT-12-717-10	White	12.70	11.10	13.64	85.09	5	10000	i7100, i5100	R6000HF

>>

B-717 Electrostatic dissipative polyimide material (continued)

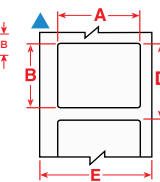
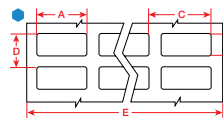

Diagram	Order Reference	Colour	Label Width A (mm)	Label Height B (mm)	Vertical Repeat D (mm)	Web Width E (mm)	Labels per Row	Labels per Roll	Printer Compatibility	Ribbon Series
B-717 : Polyimide										
▲	THT-99-717-10	White	12.70	12.70	15.24	17.78	1	10000	BBP12, i7100, i5100	R6000HF
●	THT-14-717-10	White	16.51	5.08	7.62	74.93	4	10000	BBP12, i7100, i5100	R6000HF
▲	THT-47-717-10	White	16.51	5.08	7.62	21.59	1	10000	BBP12, i7100, i5100	R6000HF
●	THT-1-717-10	White	19.05	6.35	8.89	85.09	4	10000	BBP12, i7100, i5100	R6000HF
▲	THT-46-717-10	White	19.05	6.35	8.89	24.13	1	10000	BBP12, i7100, i5100	R6000HF
▲	THT-42-717-10	White	25.40	4.75	7.29	30.48	1	10000	BBP12, i7100, i5100	R6000HF
▲	THT-103-717-10	White	25.40	6.35	8.89	30.48	1	10000	BBP12, i7100, i5100	R6000HF
▲	THT-59-717-10	White	25.40	12.70	15.24	30.48	1	10000	BBP12, i7100, i5100	R6000HF
▲	THT-44-717-10	White	34.93	6.35	8.89	40.64	1	10000	BBP12, i7100, i5100	R6000HF
▲	THT-60-717-10	White	38.10	3.18	5.72	43.18	1	10000	BBP12, i7100, i5100	R6000HF
▲	THT-45-717-10	White	38.10	6.35	8.89	43.18	1	10000	BBP12, i7100, i5100	R6000HF
▲	THT-15-717-2.5	White	50.80	6.35	9.53	55.88	1	2500	BBP12, i7100, i5100	R6000HF
▲	THT-48-717-10	White	50.80	6.35	8.89	55.88	1	10000	BBP12, i7100, i5100	R6000HF



B-718 Electrostatic dissipative polyimide material

Colour: White

Finish: Gloss

White polyimide material, low profile (1 mil thickness), with glossy finish and ultra-durable adhesive. Used in printed circuit board and electronic component pre-process labelling. Designed for use with extreme wash protocol and cleaning chemicals. Surface resistivity values in the recommended range for dissipative ESD packing materials.

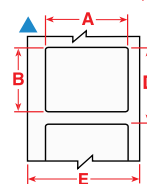
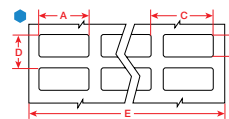

Performance attributes:



Diagram	Order Reference	Colour	Label Width A (mm)	Label Height B (mm)	Vertical Repeat D (mm)	Web Width E (mm)	Labels per Row	Labels per Roll	Printer Compatibility	Ribbon Series
B-718 : Polyimide										
●	THT-70-718-20	White	6.35	6.35	8.89	60.20	7	20000	BBP12, i7100, i5100	R6000HF
●	THT-71-718-20	White	8.00	8.00	11.43	60.71	6	20000	BBP12, i7100, i5100	R6000HF
●	THT-38-718-10	White	9.53	9.53	12.07	81.28	7	10000	BBP12, i7100, i5100	R6000HF
▲	THT-97-718-10	White	12.70	5.08	7.62	17.78	1	10000	BBP12, i7100, i5100	R6000HF
●	THT-12-718-10	White	12.70	11.10	13.64	85.09	5	10000	i7100, i5100	R6000HF
●	THT-14-718-10	White	16.51	5.08	7.62	74.93	4	10000	BBP12, i7100, i5100	R6000HF
▲	THT-47-718-10	White	16.51	5.08	7.62	21.59	1	10000	BBP12, i7100, i5100	R6000HF
●	THT-1-718-10	White	19.05	6.35	8.89	85.09	4	10000	BBP12, i7100, i5100	R6000HF
▲	THT-46-718-10	White	19.05	6.35	8.89	24.13	1	10000	BBP12, i7100, i5100	R6000HF
●	THT-2-718-10	White	22.86	6.35	8.89	85.09	3	10000	BBP12, i7100, i5100	R6000HF
▲	THT-49-718-10	White	22.86	6.35	8.89	27.94	1	10000	BBP12, i7100, i5100	R6000HF
▲	THT-42-718-10	White	25.40	4.75	7.29	30.48	1	10000	BBP12, i7100, i5100	R6000HF
▲	THT-103-718-10	White	25.40	6.35	8.89	30.48	1	10000	BBP12, i7100, i5100	R6000HF
●	THT-3-718-10	White	25.40	9.53	12.07	85.09	3	10000	BBP12, i7100, i5100	R6000HF
▲	THT-58-718-10	White	25.40	9.53	12.07	30.48	1	10000	BBP12, i7100, i5100	R6000HF
●	THT-5-718-10	White	25.40	12.70	15.24	85.09	3	10000	BBP12, i7100, i5100	R6000HF
▲	THT-59-718-10	White	25.40	12.70	15.24	30.48	1	10000	BBP12, i7100, i5100	R6000HF
▲	THT-43-718-10	White	31.75	6.35	8.89	36.83	1	10000	BBP12, i7100, i5100	R6000HF
●	THT-29-718-10	White	31.75	9.53	12.07	69.85	2	10000	BBP12, i7100, i5100	R6000HF
●	THT-4-718-10	White	38.10	6.35	8.89	85.09	2	10000	BBP12, i7100, i5100	R6000HF
▲	THT-45-718-10	White	38.10	6.35	8.89	43.18	1	10000	BBP12, i7100, i5100	R6000HF
▲	THT-72-718-10	White	44.45	6.35	8.89	49.53	1	10000	BBP12, i7100, i5100	R6000HF
▲	THT-48-718-10	White	50.80	6.35	8.89	55.88	1	10000	BBP12, i7100, i5100	R6000HF



B-719 Electrostatic dissipative polyimide material

Colour: White

Finish: Matt

White polyimide material with matt finish and ultra-durable adhesive. Used in printed circuit board and electronic component pre-process labelling. Designed for use with extreme wash protocol and cleaning chemicals. Surface resistivity values in the recommended range for dissipative ESD packing materials.

Performance attributes:

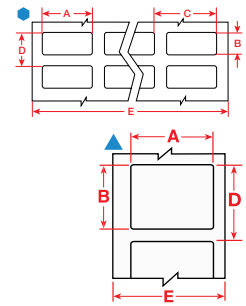

Diagram	Order Reference	Colour	Label Width A (mm)	Label Height B (mm)	Vertical Repeat D (mm)	Web Width E (mm)	Labels per Row	Labels per Roll	Printer Compatibility	Ribbon Series
B-719 : Polyimide										
●	THT-70-719-20	White	6.35	6.35	8.89	60.20	7	20000	BBP12, i7100, i5100	R6000HF
●	THT-71-719-20	White	8.00	8.00	11.43	60.71	6	20000	BBP12, i7100, i5100	R6000HF
●	THT-38-719-10	White	9.53	9.53	12.07	81.28	7	10000	BBP12, i7100, i5100	R6000HF
●	THT-12-719-10	White	12.70	11.10	13.64	85.09	5	10000	i7100, i5100	R6000HF
▲	THT-99-719-10	White	12.70	12.70	15.24	17.78	1	10000	BBP12, i7100, i5100	R6000HF
●	THT-14-719-10	White	16.51	5.08	7.62	74.93	4	10000	BBP12, i7100, i5100	R6000HF
▲	THT-47-719-10	White	16.51	5.08	7.62	21.59	1	10000	BBP12, i7100, i5100	R6000HF
●	THT-1-719-10	White	19.05	6.35	8.89	85.09	4	10000	BBP12, i7100, i5100	R6000HF
▲	THT-46-719-10	White	19.05	6.35	8.89	24.13	1	10000	BBP12, i7100, i5100	R6000HF
●	THT-2-719-10	White	22.86	6.35	8.89	85.09	3	10000	BBP12, i7100, i5100	R6000HF
▲	THT-49-719-10	White	22.86	6.35	8.89	27.94	1	10000	BBP12, i7100, i5100	R6000HF
▲	THT-42-719-10	White	25.40	4.75	7.29	30.48	1	10000	BBP12, i7100, i5100	R6000HF
▲	THT-103-719-10	White	25.40	6.35	8.89	30.48	1	10000	BBP12, i7100, i5100	R6000HF
●	THT-3-719-10	White	25.40	9.53	12.07	85.09	3	10000	BBP12, i7100, i5100	R6000HF
▲	THT-58-719-10	White	25.40	9.53	12.07	30.48	1	10000	BBP12, i7100, i5100	R6000HF
●	THT-5-719-10	White	25.40	12.70	15.24	85.09	3	10000	BBP12, i7100, i5100	R6000HF
▲	THT-59-719-10	White	25.40	12.70	15.24	30.48	1	10000	BBP12, i7100, i5100	R6000HF
▲	THT-43-719-10	White	31.75	6.35	8.89	36.83	1	10000	BBP12, i7100, i5100	R6000HF
●	THT-29-719-10	White	31.75	9.53	12.07	69.85	2	10000	BBP12, i7100, i5100	R6000HF
▲	THT-60-719-10	White	38.10	3.18	5.72	43.18	1	10000	BBP12, i7100, i5100	R6000HF
▲	THT-45-719-10	White	38.10	6.35	8.89	43.18	1	10000	BBP12, i7100, i5100	R6000HF
▲	THT-48-719-10	White	50.80	6.35	8.89	55.88	1	10000	BBP12, i7100, i5100	R6000HF



B-724 Polyimide material

Colour: Amber

Finish: Matt

Amber polyimide material with matt finish and ultra-durable adhesive. Used in printed circuit board and electronic component pre-process labelling. Designed for use with extreme wash protocol and cleaning chemicals.

Performance attributes:

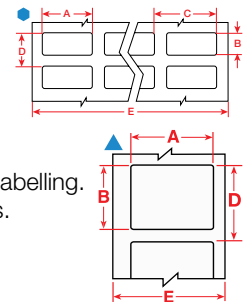

Diagram	Order Reference	Colour	Label Width A (mm)	Label Height B (mm)	Vertical Repeat D (mm)	Web Width E (mm)	Labels per Row	Labels per Roll	Printer Compatibility	Ribbon Series
B-724 : Polyimide										
●	THT-11-724-10	Amber	6.35	6.35	9.53	81.28	12	10000	BBP12, i7100, i5100	R4300, R7950
●	THT-12-724-10	Amber	12.70	11.10	13.64	85.09	5	10000	i7100, i5100	R4300, R7950
●	THT-14-724-10	Amber	16.51	5.08	7.62	74.93	4	10000	BBP12, i7100, i5100	R4300, R7950
●	THT-1-724-10	Amber	19.05	6.35	8.89	85.09	4	10000	BBP12, i7100, i5100	R4300, R7950
▲	THT-46-724-10	Amber	19.05	6.35	8.89	24.13	1	10000	BBP12, i7100, i5100	R4300, R7950
●	THT-2-724-10	Amber	22.86	6.35	8.89	85.09	3	10000	BBP12, i7100, i5100	R4300, R7950
●	THT-51-724-10	Amber	25.40	6.35	9.53	85.09	3	10000	BBP12, i7100, i5100	R4300, R7950
●	THT-3-724-10	Amber	25.40	9.53	12.07	85.09	3	10000	BBP12, i7100, i5100	R4300, R7950
●	THT-5-724-10	Amber	25.40	12.70	15.24	85.09	3	10000	BBP12, i7100, i5100	R4300, R7950
●	THT-28-724-10	Amber	38.10	3.18	6.35	85.09	2	10000	BBP12, i7100, i5100	R4300, R7950
●	THT-4-724-10	Amber	38.10	6.35	8.89	85.09	2	10000	BBP12, i7100, i5100	R4300, R7950
▲	THT-45-724-10	Amber	38.10	6.35	8.89	43.18	1	10000	BBP12, i7100, i5100	R4300, R7950
▲	THT-16-724-2.5	Amber	76.20	6.35	9.53	81.28	1	2500	BBP12, i7100, i5100	R4300, R7950



B-727 Polyimide material

Colour: White

Finish: Gloss

White polyimide material with glossy finish and ultra-durable adhesive. Used in printed circuit board and electronic component pre-process labelling. Designed for use with extreme wash protocol and cleaning chemicals.

Performance attributes:

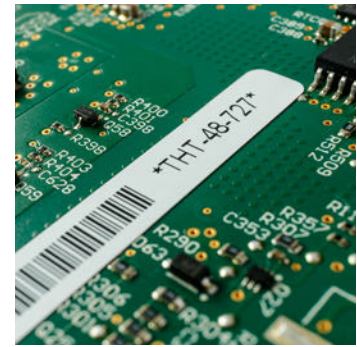
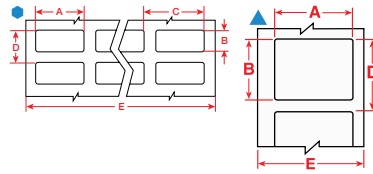

Diagram	Order Reference	Colour	Label Width A (mm)	Label Height B (mm)	Vertical Repeat D (mm)	Web Width E (mm)	Labels per Row	Labels per Roll	Printer Compatibility	Ribbon Series
B-727 : Polyimide										
●	THT-11-727-10	White	6.35	6.35	9.53	81.28	12	10000	BBP12, i7100, i5100	R6000HF
●	THT-70-727-20	White	6.35	6.35	8.89	60.20	7	20000	BBP12, i7100, i5100	R6000HF
●	THT-71-727-20	White	8.00	8.00	11.43	60.71	6	20000	i7100, i5100	R6000HF
●	THT-38-727-10	White	9.53	9.53	12.07	81.28	7	10000	BBP12, i7100, i5100	R6000HF
●	THT-12-727-10	White	12.70	11.10	13.64	85.09	5	10000	BBP12, i7100, i5100	R6000HF
●	THT-14-727-10	White	16.51	5.08	7.62	74.93	4	10000	i7100, i5100	R6000HF
▲	THT-47-727-10	White	16.51	5.08	7.62	21.59	1	10000	i7100, i5100	R6000HF
●	THT-1-727-10	White	19.05	6.35	8.89	85.09	4	10000	BBP12, i7100, i5100	R6000HF
▲	THT-46-727-10	White	19.05	6.35	8.89	24.13	1	10000	BBP12, i7100, i5100	R6000HF
●	THT-2-727-10	White	22.86	6.35	8.89	85.09	3	10000	BBP12, i7100, i5100	R6000HF
▲	THT-49-727-10	White	22.86	6.35	8.89	27.94	1	10000	BBP12, i7100, i5100	R6000HF
▲	THT-42-727-10	White	25.40	4.75	7.29	30.48	1	10000	i7100, i5100	R6000HF
▲	THT-103-727-10	White	25.40	6.35	8.89	30.48	1	10000	BBP12, i7100, i5100	R6000HF
▲	THT-58-727-10	White	25.40	9.53	12.07	30.48	1	10000	BBP12, i7100, i5100	R6000HF
▲	THT-59-727-10	White	25.40	12.70	15.24	30.48	1	10000	BBP12, i7100, i5100	R6000HF
▲	THT-43-727-10	White	31.75	6.35	8.89	36.83	1	10000	BBP12, i7100, i5100	R6000HF
●	THT-13-727-10	White	31.75	6.35	9.53	69.85	2	10000	BBP12, i7100, i5100	R6000HF
▲	THT-44-727-10	White	34.93	6.35	8.89	40.00	1	10000	BBP12, i7100, i5100	R6000HF
▲	THT-60-727-10	White	38.10	3.18	5.72	43.18	1	10000	i7100, i5100	R6000HF
▲	THT-45-727-10	White	38.10	6.35	8.89	43.18	1	10000	BBP12, i7100, i5100	R6000HF
●	THT-4-727-10	White	38.10	6.35	8.89	85.09	2	10000	BBP12, i7100, i5100	R6000HF
▲	THT-48-727-10	White	50.80	6.35	8.89	55.88	1	10000	BBP12, i7100, i5100	R6000HF



B-7727 Polyimide auto-apply label

Colour: White

Finish: Gloss

This high performing and highly reliable polyimide label for auto-apply traceability applications offers great accuracy and pick up rate to improve production continuity.

Performance attributes:

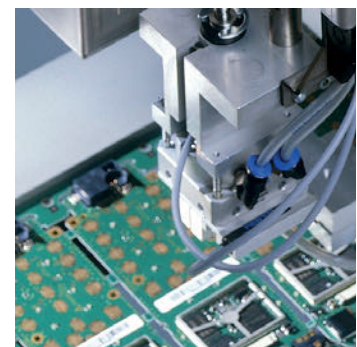
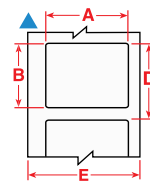
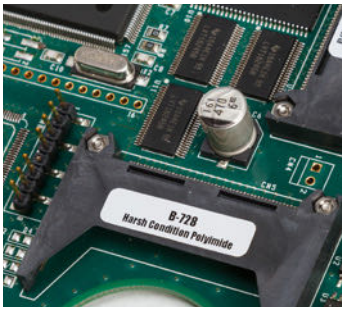

Diagram	Order Reference	Colour	Label Width A (mm)	Label Height B (mm)	Vertical Repeat D (mm)	Web Width E (mm)	Labels per Row	Labels per Roll	Printer Compatibility	Ribbon Series
B-7727 : Polyimide										
▲	THT-208-7727-10	White	5.08	5.08	7.76	25.40	1	10000	i7100, i5100	R6000HF
▲	THT-209-7727-10	White	6.35	6.35	10.16	25.00	1	10000	BBP12, i7100, i5100	R6000HF
▲	THTCLT-02-7727-5	White	6.35	6.35	9.33	25.00	1	5000	BBP12, i7100, i5100	R6000HF
▲	THTCLT-03-7727-5	White	7.00	7.11	10.00	25.00	1	5000	BBP12, i7100, i5100	R6000HF
▲	THT-210-7727-10	White	9.53	9.53	12.70	25.00	1	10000	BBP12, i7100, i5100	R6000HF
▲	THTCLT-05-7727-5	White	9.53	9.53	12.55	25.00	1	5000	BBP12, i7100, i5100	R6000HF
▲	THT-212-7727-10	White	19.05	6.35	10.16	25.00	1	10000	BBP12, i7100, i5100	R6000HF



B-728 Polyimide material

Colour: White

Finish: Matt

White polyimide material with matt finish and ultra-durable adhesive. Used in printed circuit board and electronic component pre-process labelling. Designed for use with extreme wash protocol and cleaning chemicals.

Performance attributes:

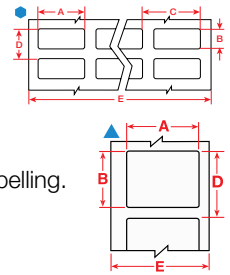

Diagram	Order Reference	Colour	Label Width A (mm)	Label Height B (mm)	Vertical Repeat D (mm)	Web Width E (mm)	Labels per Row	Labels per Roll	Printer Compatibility	Ribbon Series
B-728 : Polyimide										
▲	THT-99-728-10	White	12.70	12.70	15.24	17.78	1	10000	BBP12, i7100, i5100	R6000HF
●	THT-14-728-10	White	16.51	5.08	7.62	74.93	4	10000	BBP12, i7100, i5100	R6000HF
●	THT-1-728-10	White	19.05	6.35	8.89	85.09	4	10000	BBP12, i7100, i5100	R6000HF
▲	THT-46-728-10	White	19.05	6.35	8.89	24.13	1	10000	BBP12, i7100, i5100	R6000HF
▲	THT-59-728-10	White	25.40	12.70	15.24	30.48	1	10000	BBP12, i7100, i5100	R6000HF
▲	THT-43-728-10	White	31.75	6.35	8.89	36.83	1	10000	BBP12, i7100, i5100	R6000HF



B-729 Polyimide material

Colour: White

Finish: Satin

White polyimide material, low profile (1 mil thickness), with satin finish and ultra-durable adhesive. Used in printed circuit board and electronic component pre-process labelling. Designed for use with extreme wash protocol and cleaning chemicals.

Performance attributes:

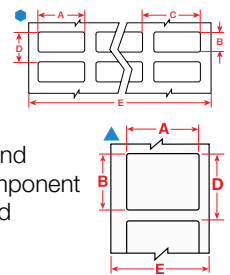
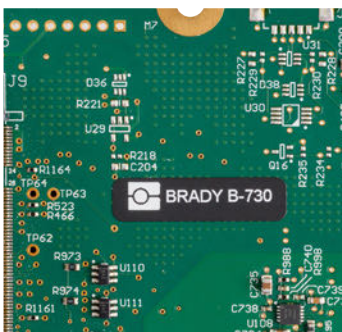

Diagram	Order Reference	Colour	Label Width A (mm)	Label Height B (mm)	Vertical Repeat D (mm)	Web Width E (mm)	Labels per Row	Labels per Roll	Printer Compatibility	Ribbon Series
B-729 : Polyimide										
●	THT-104-729-20	White	8.00	4.50	7.95	60.71	6	20000	BBP12, i7100, i5100	R6000HF
●	THT-1-729-10	White	19.05	6.35	8.89	85.09	4	10000	BBP12, i7100, i5100	R6000HF
▲	THT-103-729-10	White	25.40	6.35	8.89	30.48	1	10000	BBP12, i7100, i5100	R6000HF
▲	THT-45-729-10	White	38.10	6.35	8.89	43.18	1	10000	BBP12, i7100, i5100	R6000HF
▲	THT-48-729-10	White	50.80	6.35	8.89	55.88	1	10000	BBP12, i7100, i5100	R6000HF
▲	THT-16-729-2.5	White	76.20	6.35	9.53	81.28	1	2500	BBP12, i7100, i5100	R6000HF



B-730 Polyimide material

Colour: Black

Finish: Matt

The B-730 laser engraveable polyimide traceability label features an ultra-thin yet durable permanent adhesive that can resist high temperatures and aggressive chemicals, while avoiding adhesive bleed to reduce the risk of unplanned production stops. Specifically developed for auto-apply systems, the label is highly reliable and offers increased accuracy and pick up rate.

Performance attributes:

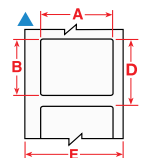

Diagram	Order Reference	Colour	Label Width A (mm)	Label Height B (mm)	Vertical Repeat D (mm)	Web Width E (mm)	Labels per Row	Labels per Roll
B-730 : Laser-engraveable Polyimide								
▲	LZR-208-730-10	Black	5.08	5.08	7.98	25.00	1	10000
▲	LZR-209-730-10	Black	6.35	6.35	10.16	25.00	1	10000
▲	LZR-210-730-10	Black	9.53	9.53	12.70	25.00	1	10000
▲	LZR-212-730-10	Black	19.00	6.35	10.16	25.00	1	10000



B-776 Polyimide material

Colour: Light Green

Finish: Gloss

Light green polyimide material with glossy finish. Used in printed circuit board and electronic component pre-process labelling.

Performance attributes:

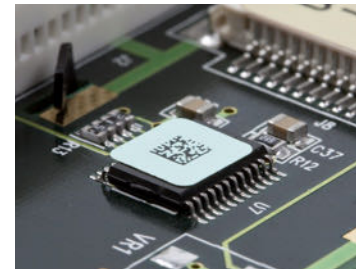
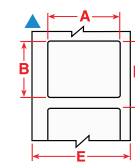
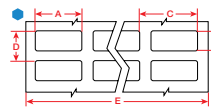

Diagram	Order Reference	Colour	Label Width A (mm)	Label Height B (mm)	Vertical Repeat D (mm)	Web Width E (mm)	Labels per Row	Labels per Roll	Printer Compatibility	Ribbon Series
B-776 : Polyimide										
●	THT-14-776-10	Light Green	16.51	5.08	7.62	74.93	4	10000	BBP12, i7100, i5100	R6000HF
▲	THT-47-776-10	Light Green	16.51	5.08	7.62	21.59	1	10000	BBP12, i7100, i5100	R6000HF
●	THT-1-776-10	Light Green	19.05	6.35	8.89	85.09	4	10000	BBP12, i7100, i5100	R6000HF
●	THT-2-776-10	Light Green	22.86	6.35	8.89	85.09	3	10000	BBP12, i7100, i5100	R6000HF
▲	THT-49-776-10	Light Green	22.86	6.35	8.89	27.94	1	10000	BBP12, i7100, i5100	R6000HF
▲	THT-59-776-10	Light Green	25.40	12.70	15.24	30.48	1	10000	BBP12, i7100, i5100	R6000HF
▲	THT-43-776-10	Light Green	31.75	6.35	8.89	36.83	1	10000	BBP12, i7100, i5100	R6000HF
▲	THT-15-776-2.5	Light Green	50.80	6.35	9.53	55.88	1	2500	BBP12, i7100, i5100	R6000HF



B-777 Custom extreme wash resistant polyimide

Colour: White

Finish: Gloss

In combination with the R6300 ink ribbon, the B-777 UltraTemp label performs well in harsh cleaning processes, with and without reflow. The white glossy polyimide B-777 label offers excellent resistance to fluxing and wave solder environments and performs in temperatures up to 300°C. The label is also extremely receptive to small font prints in text or barcode and is available in custom sizes.

Performance attributes:

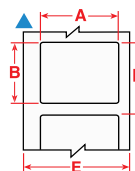

Diagram	Order Reference	Colour	Label Width A (mm)	Label Height B (mm)	Vertical Repeat D (mm)	Web Width E (mm)	Labels per Row	Labels per Roll	Printer Compatibility	Ribbon Series
B-777 : Polyimide										
▲	THT-208-777-10	White	5.08	5.08	7.98	25.00	1	10000	BBP12, i7100, i5100	R6300
▲	THT-209-777-10	White	6.35	6.35	10.16	25.00	1	10000	BBP12, i7100, i5100	R6300
▲	THT-210-777-10	White	9.53	9.53	12.70	25.00	1	10000	BBP12, i7100, i5100	R6300
▲	THT-212-777-10	White	19.05	6.35	10.16	25.00	1	10000	BBP12, i7100, i5100	R6300

B-7423 Polyester material

Colour: White

Finish: Satin

White polyester thermal transfer printable material, similar to B-8423, but specifically designed for auto apply application.

Performance attributes:

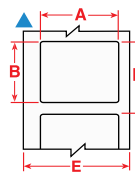

Diagram	Order Reference	Colour	Label Width A (mm)	Label Height B (mm)	Vertical Repeat D (mm)	Web Width E (mm)	Labels per Row	Labels per Roll	Printer Compatibility	Ribbon Series
B-7423 : Polyester										
▲	THT-208-7423-10	White	5.08	5.08	7.98	25.00	1	10000	BBP12, i7100, i5100	R7961
▲	THT-209-7423-10	White	6.35	6.35	10.16	25.00	1	10000	BBP12, i7100	R7961
▲	THT-210-7423-10	White	9.53	9.53	12.70	25.00	1	10000	BBP12, i7100	R7961
▲	THT-211-7423-10	White	12.70	12.70	15.88	25.00	1	10000	BBP12, i7100	R7961
▲	THT-212-7423-10	White	19.05	6.35	10.16	25.00	1	10000	BBP12, i7100	R7961

Tamper-evidence materials



B-362 Destructible vinyl material

Colour: Silver

Finish: Gloss

Metallised vinyl material with gloss finish. Tamper-evident material fractures to show signs of product tampering and prevent one-piece removal.

Performance attributes:

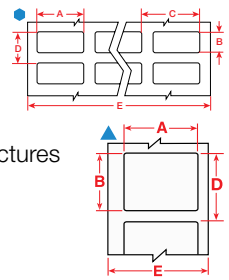
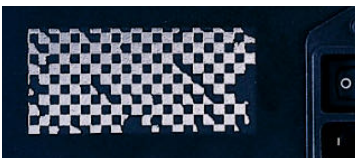
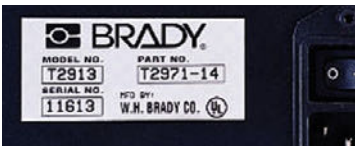

Diagram	Order Reference	Colour	Label Width A (mm)	Label Height B (mm)	Vertical Repeat D (mm)	Web Width E (mm)	Labels per Row	Labels per Roll	Printer Compatibility	Ribbon Series
B-362 : Tamper-resistant Metallised Vinyl										
●	THT-5-362-10	Silver	25.40	12.70	15.24	85.09	3	10000	BBP12, i7100, i5100	R6000HF
▲	THT-59-362-10	Silver	25.40	12.70	15.24	30.48	1	10000	BBP12, i7100, i5100	R6000HF
●	THT-37-362-10	Silver	38.10	12.70	15.24	85.09	2	10000	BBP12, i7100, i5100	R6000HF
●	THT-6-362-10	Silver	38.10	19.05	22.23	63.50	2	10000	BBP12, i7100, i5100	R6000HF
▲	THT-53-362-3	Silver	50.80	12.70	15.24	55.88	1	3000	BBP12, i7100, i5100	R6000HF
▲	THT-17-362-3	Silver	50.80	25.40	28.58	53.98	1	3000	BBP12, i7100, i5100	R6000HF
▲	THT-7-362-3	Silver	69.85	31.75	34.93	74.93	1	3000	BBP12, i7100, i5100	R6000HF
▲	THT-18-362-3	Silver	76.20	25.40	28.58	81.28	1	3000	BBP12, i7100, i5100	R6000HF
▲	THT-19-362-1	Silver	76.20	50.80	53.98	81.28	1	1000	BBP12, i7100, i5100	R6000HF



B-438 Checkerboard footprint polyester material

Colour: Silver

Finish: Matt

Metallised polyester material with matt finish. Leaves a checkerboard footprint on the surface when removed; the pattern also appears on the top of the label to prevent it from being reused.

Performance attributes:

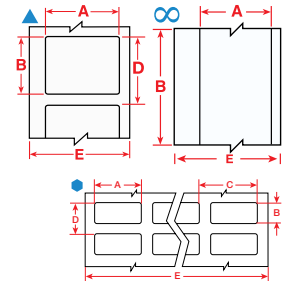

Diagram	Order Reference	Colour	Label Width A (mm)	Label Height B (mm)	Vertical Repeat D (mm)	Web Width E (mm)	Labels per Row	Labels per Roll	Printer Compatibility	Ribbon Series
B-438 : Tamper-evident Metallised Polyester										
●	THT-12-438-10	Silver	12.70	11.10	13.64	85.09	5	10000	BBP12, i7100, i5100	R4300, R7950
●	THT-14-438-10	Silver	16.51	5.08	7.62	74.93	4	10000	BBP12, i7100, i5100	R4300, R7950
●	THT-1-438-10	Silver	19.05	6.35	8.89	85.09	4	10000	BBP12, i7100, i5100	R4300, R7950
●	THT-5-438-10	Silver	25.40	12.70	15.24	85.09	3	10000	BBP12, i7100, i5100	R4300, R7950
▲	THT-17-438-3	Silver	50.80	25.40	28.58	53.98	1	3000	BBP12, i7100, i5100	R4300, R7950
▲	THT-18-438-3	Silver	76.20	25.40	28.58	81.28	1	3000	BBP12, i7100, i5100	R4300, R7950
▲	THT-19-438-1	Silver	76.20	50.80	53.98	81.28	1	1000	BBP12, i7100, i5100	R4300, R7950
∞	THT-21-438	Silver	76.20	-	-	81.28	1	1	BBP12, i7100, i5100	R4300, R7950



B-7351 Destructible vinyl material

Colour: White

Finish: Satin

White vinyl material with matt finish. Tamper-resistant material fractures to show signs of product tampering and prevent one-piece removal.

Performance attributes:

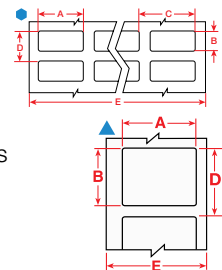

Diagram	Order Reference	Colour	Label Width A (mm)	Label Height B (mm)	Vertical Repeat D (mm)	Web Width E (mm)	Labels per Row	Labels per Roll	Printer Compatibility	Ribbon Series
B-7351 : Tamper-resistant Vinyl										
●	THT-12-7351-10	White	12.70	11.10	13.64	85.09	5	10000	i7100, i5100	R6000HF
●	THT-14-7351-10	White	16.51	5.08	7.62	74.93	4	10000	BBP12, i7100, i5100	R6000HF
●	THT-1-7351-10	White	19.05	6.35	8.89	85.09	4	10000	BBP12, i7100, i5100	R6000HF
●	THT-5-7351-10	White	25.40	12.70	15.88	85.09	3	10000	BBP12, i7100, i5100	R6000HF
●	THT-4-7351-10	White	38.10	6.35	8.89	85.09	2	10000	BBP12, i7100, i5100	R6000HF
▲	THT-15-7351-2.5	White	50.80	6.35	9.53	55.88	1	2500	BBP12, i7100, i5100	R6000HF
▲	THT-17-7351-3	White	50.80	25.40	28.58	53.98	1	3000	BBP12, i7100, i5100	R6000HF



B-7546 VOID Footprint polyester material

Colour: White

Finish: Gloss

White polyester material with glossy finish. Leaves a “VOID” footprint on the surface. The adhesive does not allow for repositioning to prevent it from being reused.

Performance attributes:

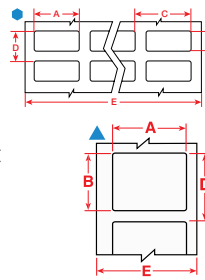

Diagram	Order Reference	Colour	Label Width A (mm)	Label Height B (mm)	Vertical Repeat D (mm)	Web Width E (mm)	Labels per Row	Labels per Roll	Printer Compatibility	Ribbon Series
B-7546 : Tamper-evident Polyester										
▲	THT-59-7546-10	White	25.40	12.70	15.24	30.48	1	10000	BBP12, i7100, i5100	R6000HF
●	THT-5-7546-10	White	25.40	12.70	15.24	85.09	3	10000	BBP12, i7100, i5100	R6000HF
●	THT-37-7546-10	White	38.10	12.70	15.24	85.09	2	10000	BBP12, i7100, i5100	R6000HF
●	THT-6-7546-10	White	38.10	19.05	22.23	85.09	2	10000	BBP12, i7100, i5100	R6000HF
▲	THT-17-7546-3	White	50.80	25.40	28.58	55.90	1	3000	BBP12, i7100, i5100	R6000HF
▲	THT-7-7546-3	White	69.85	31.75	34.93	74.93	1	3000	BBP12, i7100, i5100	R6000HF
▲	THT-18-7546-3	White	76.20	25.40	28.58	81.28	1	3000	BBP12, i7100, i5100	R6000HF
▲	THT-19-7546-1	White	76.20	50.80	53.98	81.28	1	1000	BBP12, i7100, i5100	R6000HF



B-7566 VOID Footprint polyester material

Colour: Transparent

Finish: Gloss

Clear polyester material with glossy finish. Leaves a “VOID” footprint on the surface when removed; the pattern also appears on the top of the label to prevent it from being reused.

Performance attributes:

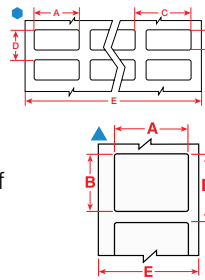

Diagram	Order Reference	Colour	Label Width A (mm)	Label Height B (mm)	Vertical Repeat D (mm)	Web Width E (mm)	Labels per Row	Labels per Roll	Printer Compatibility	Ribbon Series
B-7566 : Tamper-evident Polyester										
●	THT-39-7566-10	Transparent	25.40	12.70	15.88	85.09	3	10000	BBP12, i7100, i5100	R6000HF
●	THT-147-7566-10	Transparent	38.10	9.53	12.70	85.09	2	10000	BBP12, i7100, i5100	R6000HF
▲	THT-17-7566-3	Transparent	50.80	25.40	28.58	55.90	1	3000	BBP12, i7100, i5100	R6000HF
▲	THT-7-7566-3	Transparent	69.85	31.75	34.93	74.93	1	3000	BBP12, i7100, i5100	R6000HF



B-7576 VOID Footprint polyester material

Colour: Silver

Finish: Matt

Metallised polyester material with matt finish. Leaves a “VOID” footprint on the surface when removed; the pattern also appears on the top of the label to prevent it from being reused.

Performance attributes:

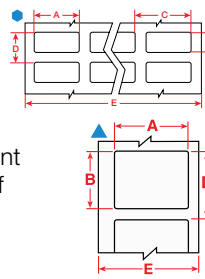
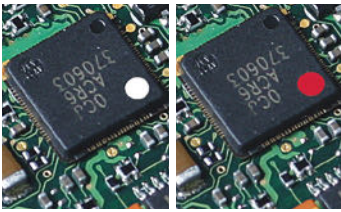

Diagram	Order Reference	Colour	Label Width A (mm)	Label Height B (mm)	Vertical Repeat D (mm)	Web Width E (mm)	Labels per Row	Labels per Roll	Printer Compatibility	Ribbon Series
B-7576 : Tamper-evident Metallised Polyester										
▲	THT-59-7576-10	Silver	25.40	12.70	15.24	30.48	1	10000	BBP12, i7100, i5100	R6000HF
●	THT-5-7576-10	Silver	25.40	12.70	15.24	85.09	3	10000	BBP12, i7100, i5100	R6000HF
●	THT-37-7576-10	Silver	38.10	12.70	15.24	85.09	2	10000	BBP12, i7100, i5100	R6000HF
●	THT-6-7576-10	Silver	38.10	19.05	22.23	85.09	2	10000	BBP12, i7100, i5100	R6000HF
▲	THT-53-7576-3	Silver	50.80	12.70	15.24	55.88	1	3000	BBP12, i7100, i5100	R6000HF
▲	THT-17-7576-3	Silver	50.80	25.40	28.58	55.90	1	3000	BBP12, i7100, i5100	R6000HF
▲	THT-7-7576-3	Silver	69.85	31.75	34.93	74.93	1	3000	BBP12, i7100, i5100	R6000HF
▲	THT-18-7576-3	Silver	76.20	25.40	28.58	81.28	1	3000	BBP12, i7100, i5100	R6000HF
▲	THT-19-7576-1	Silver	76.20	50.80	53.98	81.28	1	1000	BBP12, i7100, i5100	R6000HF

Temperature & water-indicating materials



B-350 Water-indicating material

Colour: White

Finish: Gloss

Provides clear evidence of exposure to water for controlling invalid warranty claims, failure analysis or troubleshooting.

Performance attributes:

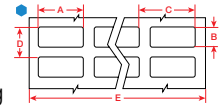

Diagram	Order Reference	Colour	Label Width A (mm)	Label Height B (mm)	Diameter C (mm)	Vertical Repeat D (mm)	Web Width E (mm)	Labels per Row	Labels per Roll	Printer Compatibility	Ribbon Series
B-350 : Water-indicating Polyester/Paper Laminate											
	THT-70-350-20	White	6.35	6.35	—	8.89	60.20	7	20000	BBP12	R4900
	WIL-1-350-5*	White	—	—	4.06	—	50.80	—	5000	BBP12, i5100	
	WIL-1-350-20*	White	—	—	4.06	—	50.80	—	20000	BBP12, i5100	



B-7511 Temperature-indicating material

Colour: White on Blue,
Blue on White

Finish: Gloss

Irreversible, temperature-indicating polyester provides a permanent record of the highest temperature reached on a piece of equipment. When the equipment reaches a certain temperature, the white area on the label turns irreversibly black, giving clear proof of the highest temperature attained. Temperature range covered is 37°C to 143°C.

Performance attributes:



Order Reference	Colour	Legend	Label Width A (mm)	Label Height B (mm)	Diameter C (mm)	Labels per Pack
B-7511 : Irreversible Temperature Indicating Polyester						
TIL-1-82C/180F	White on Blue	82°C/180°F	19.99	19.99	—	60
TIL-4-82C/180F	White on Blue	82°C/180°F - 116°C/240°F	19.99	45.01	—	30
TIL-6-37C/100F	White on Blue	37°C/100°F - 54°C/130°F	56.01	19.99	—	30
TIL-6-60C/140F	White on Blue	60°C/140°F - 82°C/180°F	56.01	19.99	—	30
TIL-6-88C/190F	White on Blue	88°C/190°F - 110°C/230°F	56.01	19.99	—	30
TIL-6-116C/240F	White on Blue	116°C/240°F - 143°C/290°F	56.01	19.99	—	30
TIL-1-60C/140F-DIA	Blue on White	60°C/140°F	—	—	6.35	60
TIL-1-71C/160F-DIA	Blue on White	71°C/160°F	—	—	6.35	60
TIL-1-82C/180F-DIA	Blue on White	82°C/180°F	—	—	6.35	60



B-7512 Temperature-indicating material

Colour: White on Blue

Finish: Gloss

Irreversible, temperature-indicating polyethylene provides a permanent record of the highest temperature reached on a piece of equipment. When the equipment reaches a certain temperature, the white area on the label turns irreversibly black, giving clear proof of the highest temperature attained. Available temperature ranges : 149°C - 177°C and 182°C - 210°C.

Performance attributes:



Order Reference	Colour	Legend	Label Width A (mm)	Label Height B (mm)	Labels per Pack
B-7512 : Polyethylene					
TIL-6-149C/300F	White on Blue	149°C/300°F - 177°C/350°F	56.01	19.99	30
TIL-6-182C/360F	White on Blue	180°C/360°F - 210°C/410°F	56.01	19.99	30



B-7518 Temperature indicating material

The reversible temperature indicating labels continue to change colour to communicate the current temperature of components or product processes, even during power loss. They can quickly show when temperatures are not right to start a next phase of product testing, maintenance, food processing or medical processes.

- Change colour at designated temperatures.
- Temperature ranges between 0°C and 100°C.
- Highly customisable.

Performance attributes:

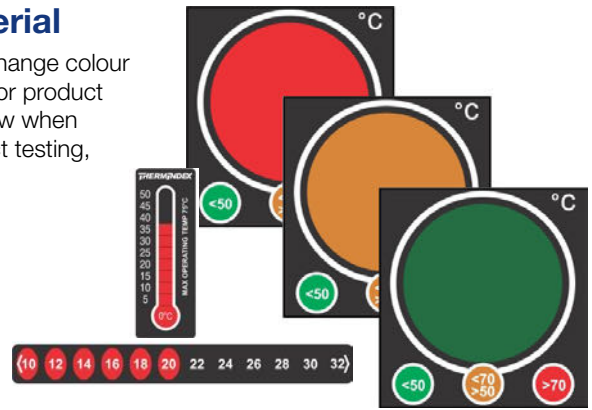

Order Reference	Colour	Legend	Label Width A (mm)	Label Height B (mm)	Diameter C (mm)	Labels per Pack
B-7518 : Sub-surface printed Polyester						
TIL-7-0C-50C	Black, Red	11-LEVEL THERMOMETER 0-50°C	18.03	50.80	–	10
TIL-7-50C-100C	Black, Red	11-LEVEL THERMOMETER 50-100°C	18.03	50.80	–	10
TIL-10-50C-70C	Green, Orange, Red	TRAFFIC LIGHT INDICATOR 50-70°C	48.01	52.07	–	10
TIL-8-10C-32C	Black, Red	12-LEVEL ROOM THERMOMETER 10-32°C	89.92	9.91	–	10
TIL-8-1C-12C	Black, Green, Red, Yellow, Blue, Orange on White	12-LEVEL FRIDGE THERMOMETER 1-12°C	89.92	9.91	–	10
TIL-9-2C-8C	Black, Red on Blue, White	COLD CHAIN INDICATOR 2-8°C	96.01	39.88	–	10
TIL-11-43C-DIA	Green, Red	GO/NO GO INDICATOR 43°C	–	–	23.88	10
TIL-12-50C-DIA	Black, Red	HAND HOT INDICATOR 50°C	–	–	37.08	10

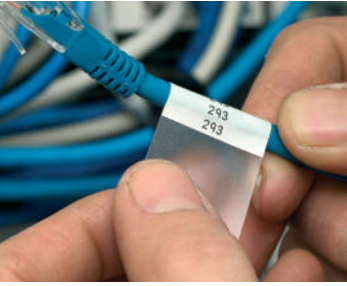

B-427 Self-laminating vinyl material

Colour: White, Transparent / Yellow, Transparent

Finish: Matt

Thermal transfer printable, self-laminating material. These labels have a white printable area with a clear “tail” that wraps around the marker. The “tail” serves as overlaminates to protect the print. Superior resistance to abrasion, solvents, water, oil and dirt.

Performance attributes:

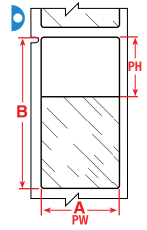

Diagram	Order Reference	Colour	Label Width A (mm)	Label Height B (mm)	Printable Area Height PH (mm)	Horizontal Repeat C (mm)	Vertical Repeat D (mm)	Web Width (mm)	Wire Diameter Range (mm)	Labels per Row	Labels per Package	Printer Compatibility	Ribbon Series
B-427 : Self-laminating Vinyl													
▶	THT-80-427-5	White, Transparent	12.70	19.05	9.53	15.24	24.13	63.50	2.54 to 3.05	4	5000	BBP12, i5100, i7100	R4300, R7950
▶	THT-61-427-5'	White, Transparent	12.70	36.50	12.70	–	17.45	41.66	3.81 to 7.62	1	5000	BBP12, i5100, i7100	R4300, R7950
▶	THT-8-427-10	White, Transparent	12.70	36.50	12.70	16.81	41.28	85.09	3.81 to 7.62	5	10000	BBP12, i5100, i7100	R4300, R7950
▶	THT-56-427-10	White, Transparent	19.05	23.80	9.53	20.32	28.58	85.09	2.29 to 4.57	4	10000	BBP12, i5100, i7100	R4300, R7950
▶	THT-62-427-3.5'	White, Transparent	19.05	44.45	12.70	–	23.80	49.53	5.08 to 10.16	1	3500	BBP12, i5100, i7100	R4300, R7950
▶	THT-73-427-10	White, Transparent	19.05	44.45	12.70	20.32	47.63	85.09	5.08 to 10.16	4	10000	BBP12, i5100, i7100	R4300, R7950
▶	THT-63-427-3.5	White, Transparent	20.32	36.50	12.70	–	25.07	41.66	3.81 to 7.62	1	3500	BBP12, i5100, i7100	R4300, R7950
▶	THT-74-427-10	White, Transparent	20.32	36.50	12.70	20.32	41.28	86.36	3.81 to 7.62	4	10000	BBP12, i5100, i7100	R4300, R7950
▶	THT-116-427-5	White, Transparent	25.40	25.40	9.53	27.94	28.58	58.42	2.54 to 5.08	2	5000	BBP12, i5100, i7100	R4300, R7950
▶	THT-9-427-10	White, Transparent	25.40	36.50	12.70	27.31	41.28	85.09	3.81 to 7.62	3	5000	BBP12, i5100, i7100	R4300, R7950
▶	THT-9-427-10-YL	Yellow, Transparent	25.40	36.50	12.70	27.31	41.28	85.09	3.90 to 7.60	3	5000	BBP12, i5100, i7100	R4300, R7950
▶	THT-64-427-3'	White, Transparent	25.40	57.15	19.05	–	30.15	62.23	6.10 to 12.19	1	3000	BBP12, i5100, i7100	R4300, R7950
▶	THT-64-427-3-YL'	Yellow, Transparent	25.40	57.15	19.05	–	30.15	62.23	6.10 to 12.10	1	3000	BBP12, i5100, i7100	R4300, R7950
▶	THT-75-427-3	White, Transparent	25.40	57.15	19.05	27.94	60.33	58.42	6.10 to 12.19	2	3000	BBP12, i5100, i7100	R4300, R7950
▶	THT-75-427-3-YL	Yellow, Transparent	25.40	57.15	19.05	27.94	60.33	58.42	6.10 to 12.10	2	3000	BBP12, i5100, i7100	R4300, R7950
▶	THT-131-427-3'	White, Transparent	25.40	66.68	25.40	–	28.58	71.63	7.10 to 13.10	1	3000	BBP12, i5100, i7100	R4300, R7950
▶	THT-10-427-3	White, Transparent	25.40	95.25	25.40	27.31	101.60	85.09	11.18 to 22.35	3	3000	BBP12, i5100, i7100	R4300, R7950
▶	THT-10-427-3-YL	Yellow, Transparent	25.40	95.25	25.40	27.31	101.60	85.09	10.10 to 22.20	3	3000	BBP12, i5100, i7100	R4300, R7950
▶	THT-65-427-3'	White, Transparent	25.40	95.25	25.40	–	30.15	100.33	11.18 to 22.35	1	3000	BBP12, i5100, i7100	R4300, R7950
▶	THT-65-427-3-YL'	Yellow, Transparent	25.40	95.25	25.40	–	30.15	100.33	10.10 to 22.20	1	3000	BBP12, i5100, i7100	R4300, R7950
▶	THT-81-427-1	White, Transparent	25.40	152.40	38.10	27.94	157.15	55.88	18.29 to 36.32	2	1000	BBP12, i5100, i7100	R4300, R7950
▶	THT-119-427-2.5	White, Transparent	38.10	38.10	12.70	–	41.28	43.18	4.00 to 8.10	1	2500	BBP12, i5100, i7100	R4300, R7950
▶	THT-66-427-1.5'	White, Transparent	48.26	80.95	19.05	–	54.61	86.11	9.91 to 19.81	1	1500	BBP12, i5100, i7100	R4300, R7950
▶	THT-67-427-1.5'	White, Transparent	50.80	57.15	19.05	–	55.55	62.23	6.10 to 12.19	1	1500	BBP12, i5100, i7100	R4300, R7950
▶	THT-27-427-1	White, Transparent	50.80	95.25	25.40	–	101.60	55.88	11.18 to 22.35	1	1000	BBP12, i5100, i7100	R4300, R7950
▶	THT-82-427-0.5	White, Transparent	50.80	152.40	38.10	–	158.80	55.88	18.29 to 36.32	1	500	BBP12, i5100, i7100	R4300, R7950
▶	THT-85-427-2'	White, Transparent	50.80	152.40	38.10	–	55.88	157.48	18.29 to 36.32	1	2000	BBP12, i5100, i7100	R4300, R7950
▶	THT-83-427-0.5	White, Transparent	50.80	177.80	38.10	–	182.55	55.88	22.35 to 44.45	1	500	BBP12, i5100, i7100	R4300, R7950
▶	THT-127-427-3'	White, Transparent	55.88	12.70	12.70	–	15.88	60.96	5.90 to 11.70	1	3000	BBP12, i5100, i7100	R4300, R7950
▶	THT-26-427-1	White, Transparent	63.50	57.15	19.05	–	61.93	68.58	6.10 to 12.19	1	1000	BBP12, i5100, i7100	R4300, R7950
▶	THT-86-427-2'	White, Transparent	178.00	50.80	38.10	–	55.88	182.88	22.35 to 44.45	1	2000	BBP12, i5100, i7100	R4300, R7950
Following part numbers are supplied on a 25 mm diameter core													
▶	BPT-305-427	White, Transparent	12.70	31.75	12.70	15.08	38.25	108.00	3.40 to 6.10	7	7000	BBP12	R7950
▶	BPT-211-427	White, Transparent	25.40	25.40	9.65	29.50	31.90	108.00	2.70 to 5.10	3	3000	BBP12	R7950
▶	BPT-311-427	White, Transparent	25.40	31.75	12.70	28.50	37.75	108.00	3.40 to 6.10	3	3000	BBP12	R7950
▶	BPT-511-427	White, Transparent	25.40	63.50	19.05	33.50	70.00	108.00	6.70 to 14.20	3	3000	BBP12	R7950
▶	BPT-517-427	White, Transparent	38.10	63.50	19.05	49.00	69.50	108.00	6.70 to 14.20	2	2000	BBP12	R7950

*Label is rotated 90° on liner.

▶ Finding the correct label height for your self-laminating labels

If you know your wire diameter or wire circumference, you can easily determine the recommended minimum and maximum label height by using the formulas below.

Step 1 Wire diameter x 3.14 (pi) = Wire circumference

Step 2 Wire circumference + printable area height (allowing clear area to cover the printable area completely at least once) = Minimum recommended label height

Step 3 Wire circumference x 3 (allowing for label to wrap 3 times around wire) = Maximum recommended label height



B-427 Rotating self-laminating vinyl material

Colour: White, Transparent

Finish: Matt

The B-427 self-laminating Rotating Label version can increase the speed of cable identification because its print can be read from any angle. The label can be rotated around a cable thanks to a non-adhesive printable zone and a translucent, self-adhesive laminate that is wrapped around a cable. Increasing the speed of cable identification can be of major importance for troubleshooting and helps to avoid time loss or human errors like unplugging the wrong cable.

Performance attributes:

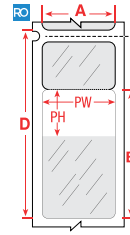

Diagram	Order Reference	Colour	Label Width A (mm)	Label Height B (mm)	Printable Area Height PH (mm)	Horizontal Repeat C (mm)	Vertical Repeat D (mm)	Web Width (mm)	Wire Diameter Range (mm)	Labels per Row	Labels per Package	Printer Compatibility	Ribbon Series
B-427 : Self-laminating Vinyl													
RO	THTRO-292-427-3	White, Transparent	12.70	44.45	17.78	17.78	65.41	53.34	2.70 to 5.13	3	3000	BBP12, i7100, i5100	R4300, R7950
RO	THTRO-293-427-3	White, Transparent	12.70	69.85	27.94	17.78	103.20	53.34	4.00 to 8.07	4	3000	BBP12, i7100, i5100	R4300, R7950
RO	THTRO-297-427-3.5	White, Transparent	25.40	30.48	12.70	31.75	46.36	62.23	2.00 to 3.65	2	3500	BBP12, i7100, i5100	R4300, R7950
RO	THTRO-294-427-2.5	White, Transparent	25.40	44.45	17.78	31.75	65.41	62.23	2.70 to 5.13	2	2500	BBP12, i7100, i5100	R4300, R7950
RO	THTRO-295-427-1.5	White, Transparent	25.40	69.85	27.94	31.75	103.20	62.23	4.00 to 8.07	2	1500	BBP12, i7100, i5100	R4300, R7950
RO	THTRO-296-427-1.5	White, Transparent	25.40	79.38	31.75	31.75	115.90	62.23	4.40 to 9.17	2	1500	BBP12, i7100, i5100	R4300, R7950
RO	THTRO-298-427	White, Transparent	25.40	165.10	66.04	31.75	234.95	62.23	8.50 to 19.07	2	700	BBP12, i7100, i5100	R4300, R7950
RO	THTRO-291-427-3	White, Transparent	31.75	55.88	20.32	37.47	79.38	74.93	6.10 to 12.10	2	3000	BBP12, i7100, i5100	R4300, R7950
RO	THTRO-299-427	White, Transparent	50.80	79.38	31.75	-	115.90	55.88	4.40 to 9.17	1	700	BBP12, i7100, i5100	R4300, R7950
RO	THTRO-300-427	White, Transparent	50.80	165.10	66.04	-	234.95	55.88	8.50 to 19.07	1	350	BBP12, i7100, i5100	R4300, R7950

B-417 Self-laminating vinyl material

Colour: White, Transparent

Finish: Matt

Thermal transfer printable, self-laminating material. These labels have a white printable area with a clear "tail" that wraps around the marker. The "tail" serves as overlamine to protect the print. Superior resistance to abrasion, solvents, water, oil and dirt. B-417 is recommended for application onto small diameter wires with low surface energy wire jacketing materials.

Performance attributes:

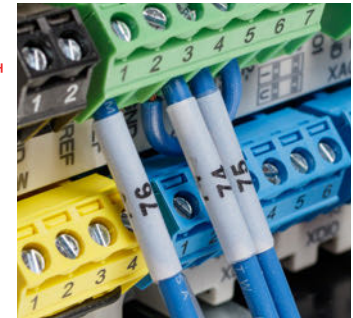
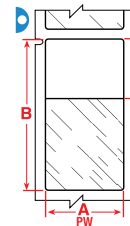

Diagram	Order Reference	Colour	Label Width A (mm)	Label Height B (mm)	Printable Area Height PH (mm)	Horizontal Repeat C (mm)	Vertical Repeat D (mm)	Web Width (mm)	Wire Diameter Range (mm)	Labels per Row	Labels per Package	Printer Compatibility	Ribbon Series
B-417 : Self-laminating Vinyl													
D	THT-80-417-5	White, Transparent	12.70	19.05	9.53	15.24	24.13	63.50	2.00 to 3.05	4	5000	BBP12, i7100, i5100	R4300, R7950
D	THT-8-417-10	White, Transparent	12.70	36.50	12.70	16.81	41.28	85.09	3.90 to 7.60	5	10000	BBP12, i7100, i5100	R4300, R7950
D	THT-56-417-10	White, Transparent	19.05	23.80	9.53	20.32	28.58	85.09	2.29 to 4.57	4	10000	BBP12, i7100, i5100	R4300, R7950
D	THT-73-417-10	White, Transparent	19.05	44.45	12.70	20.32	47.63	85.09	4.70 to 10.10	4	10000	BBP12, i7100, i5100	R4300, R7950
D	THT-116-417-5	White, Transparent	25.40	25.40	9.53	27.94	28.58	58.42	2.70 to 5.08	2	5000	BBP12, i7100, i5100	R4300, R7950
D	THT-9-417-10	White, Transparent	25.40	36.50	12.70	27.31	41.28	85.09	3.90 to 7.60	3	5000	BBP12, i7100, i5100	R4300, R7950
D	THT-64-417-3	White, Transparent	25.40	57.15	19.05	-	30.15	62.23	6.10 to 12.10	1	3000	BBP12, i7100, i5100	R4300, R7950
D	THT-75-417-3	White, Transparent	25.40	57.15	19.05	27.94	60.33	58.42	6.10 to 12.10	2	3000	BBP12, i7100, i5100	R4300, R7950
D	THT-10-417-3	White, Transparent	25.40	95.25	25.40	27.31	101.60	85.09	10.10 to 22.20	3	3000	BBP12, i7100, i5100	R4300, R7950
D	THT-65-417-3	White, Transparent	25.40	95.25	25.40	-	30.15	100.33	10.10 to 22.20	1	3000	BBP12, i7100, i5100	R4300, R7950
D	THT-81-417-1	White, Transparent	25.40	152.40	38.10	27.94	157.15	55.88	16.20 to 36.40	2	1000	BBP12, i7100, i5100	R4300, R7950
D	THT-119-417-2.5	White, Transparent	38.10	38.10	12.70	-	41.40	43.18	4.06 to 8.10	1	2500	BBP12, i7100, i5100	R4300, R7950
D	THT-66-417-1.5	White, Transparent	48.26	80.95	19.05	-	54.61	86.03	8.60 to 19.70	1	1500	BBP12, i7100, i5100	R4300, R7950
D	THT-67-417-1.5	White, Transparent	50.80	57.15	19.05	-	55.55	62.23	6.10 to 12.10	1	1500	BBP12, i7100, i5100	R4300, R7950
D	THT-27-417-1	White, Transparent	50.80	95.25	25.40	-	101.60	55.88	10.10 to 22.20	1	1000	BBP12, i7100, i5100	R4300, R7950
D	THT-83-417-0.5	White, Transparent	50.80	177.80	38.10	-	182.55	55.88	18.90 to 44.50	1	500	BBP12, i7100, i5100	R4300, R7950
D	THT-26-417-1	White, Transparent	63.50	57.15	19.05	-	61.93	68.58	6.10 to 12.10	1	1000	BBP12, i7100, i5100	R4300, R7950



B-425 Polypropylene material

Colour: White

Finish: Matt

White polypropylene material stock with matt finish for thermal transfer printing or write-on applications. Excellent solvent resistance and print performance; not recommended for long-term outdoor use.

Performance attributes:

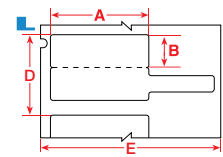
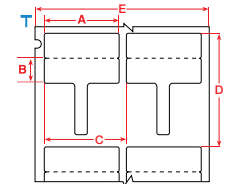

Diagram	Order Reference	Colour	Label Width A (mm)	Label Height B (mm)	Vertical Repeat D (mm)	Web Width E (mm)	Labels per Row	Labels per Roll	Printer Compatibility	Ribbon Series
B-425A : Polypropylene										
	THTFP-01-425	White	30.00	10.00	26.03	55.88	1	2500	BBP12, i7100, i5100	R4300, R7950
	THTFT-01-425	White	30.00	10.00	46.04	69.00	2	2500	BBP12, i7100, i5100	R4300, R7950



B-437 Polyvinylfluoride material

Colour: White, Yellow

Finish: Matt

White or yellow polyvinylfluoride label material with matt finish. Used in wire and cable identification applications where self-extinguishing features are required. This label material utilises an adhesive for heavy-duty applications and is available in continuous or die-cut formats. Excellent resistance to water, oil and other common fluids.

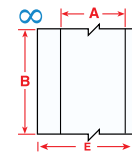
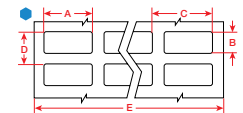

Diagram	Order Reference	Colour	Label Width A (mm)	Label Height B (mm)	Label Length B (m)	Vertical Repeat D (mm)	Web Width E (mm)	Labels per Row	Labels per Roll	Printer Compatibility	Ribbon Series
B-437 : Polyvinylfluoride											
	THT-1-437W-10	White	19.05	6.35	-	8.89	85.09	4	10000	BBP12, i7100, i5100	R4300, R7950
	THT-2-437-10	White	22.86	6.35	-	8.89	85.09	3	10000	BBP12, i7100, i5100	R4300, R7950
	THT-5-437-10	White	25.40	12.70	-	15.24	85.09	3	10000	BBP12, i7100, i5100	R4300, R7950
	THT-5-437-10-YL	Yellow	25.40	12.70	-	15.24	85.09	3	10000	BBP12, i7100, i5100	R4300, R7950
	THT-29-437-10	White	31.75	9.53	-	12.07	69.85	2	10000	BBP12, i7100, i5100	R4300, R7950
	THT-29-437-10-YL	Yellow	31.75	9.53	-	12.07	69.85	2	10000	BBP12, i7100, i5100	R4300, R7950
	THT-21-437	White	76.20	-	91.44 m	-	81.28	1	1	BBP12, i7100, i5100	R4300, R7950
	THT-21-437-YL	Yellow	76.20	-	91.44 m	-	81.28	1	1	BBP12, i7100, i5100	R4300, R7950



B-472 Polyimide material

Colour: White, Yellow

Finish: Matt

B-472 is specifically designed to self-extinguish and prevent flames from propagating. This material is ideal for wire and cable identification in extreme environments, particularly in the aerospace, defense and mass transit industries.

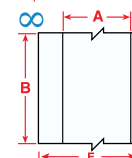
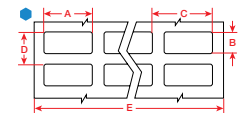

Diagram	Order Reference	Colour	Label Width A (mm)	Label Height B (mm)	Label Length B (m)	Vertical Repeat D (mm)	Web Width E (mm)	Labels per Row	Labels per Roll	Printer Compatibility	Ribbon Series
B-472 : Polyimide											
	THT-1-472-10-YL	Yellow	19.05	6.35	-	8.89	85.09	4	10000	BBP12, i7100, i5100	R4300, R7950
	THT-5-472-10	White	25.40	12.70	-	15.88	85.09	3	10000	BBP12, i7100, i5100	R4300, R7950
	THT-29-472-10	White	31.75	9.53	-	12.07	69.85	2	10000	BBP12, i7100, i5100	R4300, R7950
	THT-29-472-10-YL	Yellow	31.75	9.53	-	12.07	69.85	2	10000	BBP12, i7100, i5100	R4300, R7950
	THT-105-472-YL	Yellow	38.10	-	91.44 m	-	43.18	1	1	BBP12, i7100, i5100	R4300, R6200
	THT-106-472	White	50.80	-	91.44 m	-	55.88	1	1	BBP12, i7100, i5100	R4300, R6200



B-498 Repositionable vinyl cloth material

Colour: White

Finish: Semi-gloss

White vinyl cloth label material with semi-gloss finish. The adhesive and cloth backing give excellent holding power, while being repositionable and cleanly removable.

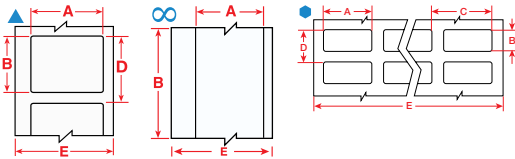

Performance attributes:



Diagram	Order Reference	Colour	Label Width A (mm)	Label Height B (mm)	Label Length B (m)	Vertical Repeat D (mm)	Web Width E (mm)	Labels per Row	Labels per Roll	Printer Compatibility	Ribbon Series
B-498 : Vinyl Cloth											
▲	THT-253-498-3	White	4.78	76.20	–	7.32	30.48	1	3000	BBP12, i7100, i5100	R4300, R7950
∞	THT-94-498	White	6.10	–	50.29 m	–	25.40	1	1	BBP12, i7100, i5100	R4300, R7950
●	THT-90-498-5	White	6.35	36.50	–	39.67	55.88	6	5000	BBP12, i7100, i5100	R4300, R7950
∞	THT-93-498	White	8.00	–	50.29 m	–	25.40	1	1	BBP12, i7100, i5100	R4300, R7950
∞	THT-92-498	White	9.53	–	50.29 m	–	25.40	1	1	BBP12, i7100, i5100	R4300, R7950
●	THT-68-498-10	White	12.70	19.05	–	21.59	63.50	4	10000	BBP12, i7100, i5100	R4300, R7950
●	THT-87-498-5	White	12.70	36.50	–	39.67	93.98	6	5000	BBP12, i7100, i5100	R4300, R7950
●	THT-14-498-10	White	16.51	5.08	–	7.62	74.93	4	10000	BBP12, i7100, i5100	R4300, R7950
▲	THT-252-498-3	White	19.05	6.35	–	8.89	25.40	1	3000	BBP12, i7100, i5100	R4300, R7950
●	THT-1-498-10	White	19.05	6.35	–	8.89	85.09	4	10000	BBP12, i7100, i5100	R4300, R7950
▲	THT-254-498-3	White	19.05	19.05	–	21.59	25.40	1	3000	BBP12, i7100, i5100	R4300, R7950
●	THT-91-498-5	White	19.05	23.80	–	26.97	88.90	4	5000	BBP12, i7100, i5100	R4300, R7950
●	THT-88-498-5	White	19.05	25.40	–	22.23	58.42	2	5000	BBP12, i7100, i5100	R4300, R7950
●	THT-95-498-5	White	20.32	36.50	–	39.67	71.12	3	5000	BBP12, i7100, i5100	R4300, R7950
▲	THT-59-498-10	White	25.40	12.70	–	15.24	30.48	1	10000	BBP12, i7100, i5100	R4300, R7950
●	THT-5-498-10	White	25.40	12.70	–	15.24	85.09	3	10000	BBP12, i7100, i5100	R4300, R7950
●	THT-89-498-5	White	25.40	36.50	–	39.67	86.36	3	5000	BBP12, i7100, i5100	R4300, R7950
▲	THT-199-498-3	White	26.67	6.35	–	8.89	31.75	1	3000	BBP12, i7100, i5100	R4300, R7950
▲	THT-17-498-3	White	50.80	25.40	–	28.58	55.88	1	3000	BBP12, i7100, i5100	R4300, R7950
Following part numbers are mounted on a 25 mm diameter core and do not require the unwinder for use with the BBP12 Printer.											
●	BPT-611-498	White	12.70	25.40	–	28.40	50.10	3	3000	BBP12	R7950
▲	BPT-659-498	White	25.40	12.45	–	15.40	30.48	1	1000	BBP12	R7950
▲	THT-59-498-2.5-SC	White	25.40	12.70	–	15.24	30.48	1	1250	BBP12	R7950
●	BPT-621-498	White	25.40	36.50	–	39.50	88.20	3	3000	BBP12	R7950
▲	THT-17-498-1.5-SC	White	50.80	25.40	–	28.58	55.88	1	750	BBP12	R7950

▶ Did you know? - Technical data sheets

Looking for more information regarding a certain Brady material? Brady offers online access to technical data sheets for all Brady materials. View a specific B-number or search by relevant keywords. Visit www.bradyeurope.com/tds for more information.





B-499 Nylon cloth material

Colour: White

Finish: Matt

White nylon cloth material with matt finish. The adhesive allows labelling in environments with heat, cold, oil and dirt.

Performance attributes:

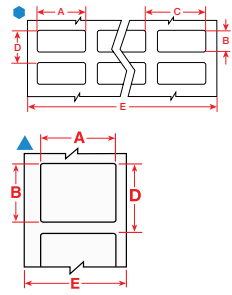

Diagram	Order Reference	Colour	Label Width A (mm)	Label Height B (mm)	Vertical Repeat D (mm)	Web Width E (mm)	Labels per Row	Labels per Roll	Printer Compatibility	Ribbon Series
B-499 : Nylon Cloth										
●	THT-68-499-10	White	12.70	19.05	21.59	63.50	4	10000	BBP12, i7100, i5100	R4900
●	THT-69-499-3	White	20.32	36.50	39.12	48.26	2	3000	BBP12, i7100, i5100	R4900
▲	THT-125-499-3	White	22.86	12.70	15.24	27.94	1	3000	BBP12, i7100, i5100	R4900
●	THT-152-499-3	White	25.40	9.53	12.07	58.42	2	3000	BBP12, i7100, i5100	R4900
▲	THT-136-499-3	White	38.10	19.05	22.23	43.18	1	3000	BBP12, i7100, i5100	R4900
▲	THT-151-499-3	White	50.80	6.35	8.89	55.88	1	3000	BBP12, i7100, i5100	R4900
▲	THT-137-499-3	White	50.80	25.40	28.58	55.88	1	3000	BBP12, i7100, i5100	R4900
Following part numbers are mounted on a 25 mm diameter core and do not require the unwider for use with the BBP12 Printer.										
●	BPT-611-499	White	12.70	25.40	28.40	50.10	3	3000	BBP12	R7950
▲	BPT-620-499	White	12.70	25.40	28.40	25.40	1	1000	BBP12	R7950
▲	THT-125-499-1.5-SC	White	22.86	12.70	15.24	27.94	1	1500	BBP12	R7950, R4300, R4900
●	BPT-618-499	White	22.86	38.10	41.10	50.10	3	3000	BBP12	R7950
●	THT-152-499-1.5-SC	White	25.40	9.53	15.88	58.42	2	1500	BBP12	R7950, R4300, R4900
▲	BPT-659-499	White	25.40	12.45	15.40	30.48	1	1000	BBP12	R7950
●	BPT-621-499	White	25.40	36.50	39.50	88.20	3	3000	BBP12	R7950
●	BPT-625-499	White	25.40	66.68	69.68	88.20	3	1500	BBP12	R7950
▲	THT-136-499-1.5-SC	White	38.10	19.05	22.23	43.18	1	1500	BBP12	R7950, R4300, R4900
▲	THT-151-499-1.5-SC	White	50.80	6.35	8.89	55.88	1	1500	BBP12	R7950, R4300, R4900





Wire & cable tags

Brady's printable wire and cable tags provide you with the ability to create clear, unambiguous cable identification tags for both indoor and outdoor applications. Cable identification tags can be attached to a wire, cable, or bundle using cable ties or lacing cord.

With Brady's variety of cable tags, you can identify data centre wires, audio visual cables, power and ground cables, cable harnesses, and more. Brady's tag materials offer excellent tear, solvent and heat resistance.

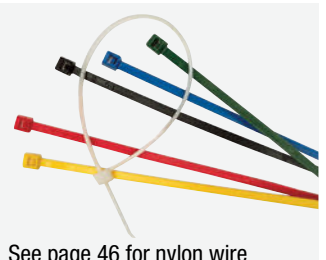

See page 46 for nylon wire and cable ties.

Cable tag material comparison chart

	B-109 Tag	B-412 Tag	B-508 Nomex® Cable Marker	B-7597 Tag	B-7599 Rapido Wire Markers	B-7643 Cable Tag	B-7644 Laminat Carriers	B-7598 Tag
Material	Polyethylene	Polypropylene	Polymer	Polyethylene	Polyethylene	Polyurethane	Polypropylene	Polyester
Abrasion resistance				✓	✓		✓	✓
Fuel/oil resistance	✓	✓	✓					✓
High heat resistance (100°C)			✓					✓
Low temperature resistance (< -40°C)	✓		✓			✓		✓
Solvent/Chemical resistance								✓
Outdoor use			✓				✓	✓
Tear resistance	✓	✓	✓	✓	✓			✓
Harsh environments			✓			✓	✓	✓
Different colours	White Yellow	White	White Yellow Green	White Yellow	White Yellow	White Yellow Red Green Blue Orange Black	Yellow	White Yellow Red Green Blue Silver Black
Halogen Free	✓	✓		✓	✓	✓	✓	✓*

*White and black only

B-109 Polyethylene tag material

Color: White

Finish: Matt

White polyethylene tag material with matt finish. Excellent multi-purpose tag for identifying multi-conductor cables, inventory, safety warning repair and work-in-process manufacturing. Good weatherability, humidity resistance and legibility after solvent exposure.

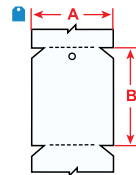

Performance attributes:



Diagram	Order Reference	Colour	Label Width A (mm)	Label Height B (mm)	Labels per Row	Labels per Roll	Printer Compatibility	Ribbon Series
B-109 : Polyethylene								
	THT-33-109-0.5	White	76.20	152.40	1	500	BBP12, i5100, i7100	R4300, R7950

B-412 Polypropylene tag material

Color: White

Finish: Matt

White polypropylene tag material with matt finish. Offers high print legibility and high tensile strength.

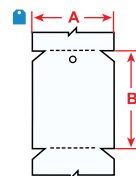

Performance attributes:



Diagram	Order Reference	Colour	Label Width A (mm)	Label Height B (mm)	Labels per Row	Labels per Roll	Printer Compatibility	Ribbon Series
B-412 : Polypropylene								
	THT-33-412-1	White	76.20	152.40	1	1000	BBP12, i5100, i7100	R4300, R7950

Wire and cable materials



B-508 Nomex® Cable marker

Colour: White/Yellow

Finish: Matt

Thermal transfer and dot matrix printable wire and cable bundle tag for harsh environments. Excellent tear, heat and solvent resistance.

Performance attributes

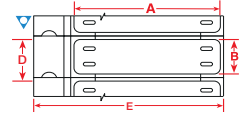

Diagram	Order Reference	Colour	Label Width A (mm)	Label Height B (mm)	Vertical Repeat D (mm)	Web Width E (mm)	Labels per Row	Labels per Roll	Printer Compatibility	Ribbon Series
B-508 : Nomex® Tag										
▼	HSNX-400-2-WT	White	55.88	10.41	15.79	82.55	1	2500	i5100, i7100	R4300, R7950
▼	HSNX-400-2-YL	Yellow	55.88	10.41	15.79	82.55	1	2500	i5100, i7100	R4300, R7950
▼	HSNX-800-2-WT	White	55.88	20.32	25.70	82.55	1	2500	i5100, i7100	R4300, R7950
▼	HSNX-800-2-YL	Yellow	55.88	20.32	25.70	82.55	1	2500	i5100, i7100	R4300, R7950



B-7597 Polyethylene tag material

Colour: White

Finish: Matt

White polyethylene tag material. Resists tearing and the topcoat resists smudging and abrasion. Low halogen material.

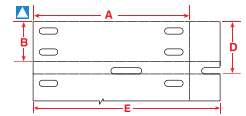

Diagram	Order Reference	Colour	Label Width A (mm)	Label Height B (mm)	Vertical Repeat D (mm)	Web Width E (mm)	Labels per Row	Labels per Roll	Printer Compatibility	Ribbon Series
B-7597 : Polyethylene										
▲	BPT-7597W-2050	White	50.80	12.70	16.72	60.80	1	2000	BBP12	R4300, R7950
▲	BT-7597W-2050	White	50.80	12.70	16.72	60.80	1	4000	BBP12, i5100, i7100	R4300, R7950



B-7598 Polyester cable tag

Colour: Various

Finish: Gloss

The B-7598 polyester tag is a general identification tag for cables exposed to extreme conditions. It requires cable ties to apply to cables with various diameters. Common applications for this cable tag material are:

- Identification of multi-conductor cables
- Identification of cables in mobile phone towers
- Identification of datacom or telecom cables in general
- General cable identification that must be extremely resistant



Diagram	Order Reference	Colour	Label Width A (mm)	Label Height B (mm)	Vertical Repeat D (mm)	Labels per Row	Labels per Package	Printer Compatibility	Ribbon Series
B-7598 : Polyester									
≡	THT-6010-7598-WT	White	60.00	10.00	15.08	1	1000	i7100, i5100	R6000HF
≡	THT-6010-7598-YL	Yellow	60.00	10.00	15.08	1	1000	i7100, i5100	R6000HF
≡	THT-6010-7598-GN	Green	60.00	10.00	15.08	1	1000	i7100, i5100	R6000HF
≡	THT-6010-7598-RD	Red	60.00	10.00	15.08	1	1000	i7100, i5100	R6000HF
≡	THT-6010-7598-SV	Silver	60.00	10.00	15.08	1	1000	i7100, i5100	R6000HF
≡	THT-6010-7598-BK	Black	60.00	10.00	15.08	1	1000	i7100, i5100	R4400-WT
≡	THT-6010-7598-BL	Blue	60.00	10.00	15.08	1	1000	i7100, i5100	R6000HF
≡	THT-7510-7598-WT	White	75.00	10.00	15.08	1	1000	i7100, i5100	R6000HF
≡	THT-7510-7598-YL	Yellow	75.00	10.00	15.08	1	1000	i7100, i5100	R6000HF
≡	THT-7510-7598-GN	Green	75.00	10.00	15.08	1	1000	i7100, i5100	R6000HF
≡	THT-7510-7598-RD	Red	75.00	10.00	15.08	1	1000	i7100, i5100	R6000HF
≡	THT-7510-7598-SV	Silver	75.00	10.00	15.08	1	1000	i7100, i5100	R6000HF
≡	THT-7510-7598-BK	Black	75.00	10.00	15.08	1	1000	i7100, i5100	R4400-WT
≡	THT-7510-7598-BL	Blue	75.00	10.00	15.08	1	1000	i7100, i5100	R6000HF

>>

B-7598 Polyester cable tag (continued)



Diagram	Order Reference	Colour	Label Width A (mm)	Label Height B (mm)	Vertical Repeat D (mm)	Labels per Row	Labels per Package	Printer Compatibility	Ribbon Series
B-7598 : Polyester									
	THT-7515-7598-WT	White	75.00	15.00	20.02	1	1000	i7100, i5100	R6000HF
	THT-7515-7598-YL	Yellow	75.00	15.00	20.02	1	1000	i7100, i5100	R6000HF
	THT-7515-7598-GN	Green	75.00	15.00	20.02	1	1000	i7100, i5100	R6000HF
	THT-7515-7598-RD	Red	75.00	15.00	20.02	1	1000	i7100, i5100	R6000HF
	THT-7515-7598-SV	Silver	75.00	15.00	20.02	1	1000	i7100, i5100	R6000HF
	THT-7515-7598-BK	Black	75.00	15.00	20.02	1	1000	i7100, i5100	R4400-WT
	THT-7515-7598-BL	Blue	75.00	15.00	20.02	1	1000	i7100, i5100	R6000HF
	THT-7525-7598-WT	White	75.00	25.00	30.16	1	500	i7100, i5100	R6000HF
	THT-7525-7598-YL	Yellow	75.00	25.00	30.16	1	500	i7100, i5100	R6000HF
	THT-7525-7598-GN	Green	75.00	25.00	30.16	1	500	i7100, i5100	R6000HF
	THT-7525-7598-RD	Red	75.00	25.00	30.16	1	500	i7100, i5100	R6000HF
	THT-7525-7598-SV	Silver	75.00	25.00	30.16	1	500	i7100, i5100	R6000HF
	THT-7525-7598-BK	Black	75.00	25.00	30.16	1	500	i7100, i5100	R4400-WT
	THT-7525-7598-BL	Blue	75.00	25.00	30.16	1	500	i7100, i5100	R6000HF
Following part numbers are mounted on a 25 mm diameter core and do not require the unwinder for use with the BBP12 Printer.									
	BPT-6010-7598-WT	White	60.00	10.00	15.08	1	1000	BBP12	R6000HF
	BPT-6010-7598-YL	Yellow	60.00	10.00	15.08	1	1000	BBP12	R6000HF
	BPT-6010-7598-GN	Green	60.00	10.00	15.08	1	1000	BBP12	R6000HF
	BPT-6010-7598-RD	Red	60.00	10.00	15.08	1	1000	BBP12	R6000HF
	BPT-6010-7598-SV	Silver	60.00	10.00	15.08	1	1000	BBP12	R6000HF
	BPT-6010-7598-BK	Black	60.00	10.00	15.08	1	1000	BBP12	R4400-WT
	BPT-6010-7598-BL	Blue	60.00	10.00	15.08	1	1000	BBP12	R6000HF
	BPT-7510-7598-WT	White	75.00	10.00	15.08	1	1000	BBP12	R6000HF
	BPT-7510-7598-YL	Yellow	75.00	10.00	15.08	1	1000	BBP12	R6000HF
	BPT-7510-7598-GN	Green	75.00	10.00	15.08	1	1000	BBP12	R6000HF
	BPT-7510-7598-RD	Red	75.00	10.00	15.08	1	1000	BBP12	R6000HF
	BPT-7510-7598-SV	Silver	75.00	10.00	15.08	1	1000	BBP12	R6000HF
	BPT-7510-7598-BK	Black	75.00	10.00	15.08	1	1000	BBP12	R4400-WT
	BPT-7510-7598-BL	Blue	75.00	10.00	15.08	1	1000	BBP12	R6000HF
	BPT-7515-7598-WT	White	75.00	15.00	20.02	1	1000	BBP12	R6000HF
	BPT-7515-7598-YL	Yellow	75.00	15.00	20.02	1	1000	BBP12	R6000HF
	BPT-7515-7598-GN	Green	75.00	15.00	20.02	1	1000	BBP12	R6000HF
	BPT-7515-7598-RD	Red	75.00	15.00	20.02	1	1000	BBP12	R6000HF
	BPT-7515-7598-SV	Silver	75.00	15.00	20.02	1	1000	BBP12	R6000HF
	BPT-7515-7598-BK	Black	75.00	15.00	20.02	1	1000	BBP12	R4400-WT
	BPT-7515-7598-BL	Blue	75.00	15.00	20.02	1	1000	BBP12	R6000HF
	BPT-7525-7598-WT	White	75.00	25.00	30.16	1	500	BBP12	R6000HF
	BPT-7525-7598-YL	Yellow	75.00	25.00	30.16	1	500	BBP12	R6000HF
	BPT-7525-7598-GN	Green	75.00	25.00	30.16	1	500	BBP12	R6000HF
	BPT-7525-7598-RD	Red	75.00	25.00	30.16	1	500	BBP12	R6000HF
	BPT-7525-7598-SV	Silver	75.00	25.00	30.16	1	500	BBP12	R6000HF
	BPT-7525-7598-BK	Black	75.00	25.00	30.16	1	500	BBP12	R4400-WT
	BPT-7525-7598-BL	Blue	75.00	25.00	30.16	1	500	BBP12	R6000HF



B-7599 Rapido Wire markers

Colour: Yellow

Finish: Matt

Yellow coated polyethylene tag suitable for durable terminated wire marking for electrical devices and fibre installations.

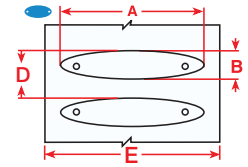

Diagram	Order Reference	Colour	Label Width A (mm)	Label Height B (mm)	Vertical Repeat D (mm)	Web Width E (mm)	Labels per Row	Labels per Package	Printer Compatibility	Ribbon Series
B-7599 : Polyethylene										
	THT-01-7599-YL	Yellow	23.00	5.20	8.40	35.90	1	2500	BBP12, i7100, i5100	R7950
	THT-02-7599-YL	Yellow	23.00	5.20	8.38	36.00	1	2500	BBP12, i7100, i5100	R7950
	THT-03-7599-YL	Yellow	25.00	5.70	8.89	38.00	1	2500	BBP12, i7100, i5100	R7950
	THT-04-7599_YL	Yellow	26.00	7.00	20.36	39.00	1	1500	BBP12, i7100, i5100	R7950
	THT-05-7599-YL	Yellow	41.00	11.00	14.20	54.00	1	1500	BBP12, i7100, i5100	R7950



B-7643 Halogen-free cable tag

Colour: Various

Finish: Matt

Thermal transfer and dot matrix printable wire and cable bundle tag in polyurethane for harsh environments. Low halogen material.

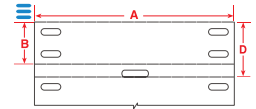

Performance attributes



Diagram	Order Reference	Colour	Label Width A (mm)	Label Height B (mm)	Vertical Repeat D (mm)	Labels per Row	Labels per Package	Printer Compatibility	Ribbon Series
B-7643 : Thermoplastic Polyether Polyurethane									
	THT-6010-7643-WT	White	60.00	10.00	15.08	1	750	i7100, i5100	R6000HF
	THT-6010-7643-YL	Yellow	60.00	10.00	15.08	1	750	i7100, i5100	R6000HF
	THT-6010-7643-GN	Green	60.00	10.00	15.08	1	750	i7100, i5100	R6000HF
	THT-6010-7643-RD	Red	60.00	10.00	15.08	1	750	i7100, i5100	R6000HF
	THT-6010-7643-OR	Orange	60.00	10.00	15.08	1	750	i7100, i5100	R6000HF
	THT-6010-7643-BK	Black	60.00	10.00	15.08	1	750	i7100, i5100	R4400-WT
	THT-6010-7643-BL	Blue	60.00	10.00	15.08	1	750	i7100, i5100	R6000HF
	THT-7510-7643-WT	White	75.00	10.00	15.08	1	750	i7100, i5100	R6000HF
	THT-7510-7643-YL	Yellow	75.00	10.00	15.08	1	750	i7100, i5100	R6000HF
	THT-7510-7643-GN	Green	75.00	10.00	15.08	1	750	i7100, i5100	R6000HF
	THT-7510-7643-RD	Red	75.00	10.00	15.08	1	750	i7100, i5100	R6000HF
	THT-7510-7643-OR	Orange	75.00	10.00	15.08	1	750	i7100, i5100	R6000HF
	THT-7510-7643-BK	Black	75.00	10.00	15.08	1	750	i7100, i5100	R4400-WT
	THT-7510-7643-BL	Blue	75.00	10.00	15.08	1	750	i7100, i5100	R6000HF
	THT-7515-7643-WT	White	75.00	15.00	20.02	1	500	i7100, i5100	R6000HF
	THT-7515-7643-YL	Yellow	75.00	15.00	20.02	1	500	i7100, i5100	R6000HF
	THT-7515-7643-GN	Green	75.00	15.00	20.02	1	500	i7100, i5100	R6000HF
	THT-7515-7643-RD	Red	75.00	15.00	20.02	1	500	i7100, i5100	R6000HF
	THT-7515-7643-OR	Orange	75.00	15.00	20.02	1	500	i7100, i5100	R6000HF
	THT-7515-7643-BK	Black	75.00	15.00	20.02	1	500	i7100, i5100	R4400-WT
	THT-7515-7643-BL	Blue	75.00	15.00	20.02	1	500	i7100, i5100	R6000HF
	THT-7525-7643-WT	White	75.00	25.00	30.16	1	250	i7100, i5100	R6000HF

>>

B-7643 Halogen-free cable tag (continued)

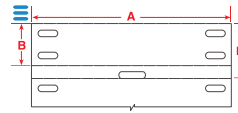

Diagram	Order Reference	Colour	Label Width A (mm)	Label Height B (mm)	Vertical Repeat D (mm)	Labels per Row	Labels per Package	Printer Compatibility	Ribbon Series
B-7643 : Thermoplastic Polyether Polyurethane									
	THT-7525-7643-YL	Yellow	75.00	25.00	30.16	1	250	i7100, i5100	R6000HF
	THT-7525-7643-GN	Green	75.00	25.00	30.16	1	250	i7100, i5100	R6000HF
	THT-7525-7643-RD	Red	75.00	25.00	30.16	1	250	i7100, i5100	R6000HF
	THT-7525-7643-OR	Orange	75.00	25.00	30.16	1	250	i7100, i5100	R6000HF
	THT-7525-7643-BK	Black	75.00	25.00	30.16	1	250	i7100, i5100	R4400-WT
	THT-7525-7643-BL	Blue	75.00	25.00	30.16	1	250	i7100, i5100	R6000HF
Following part numbers are mounted on a 25 mm diameter core and do not require the unwinder for use with the BBP12 Printer.									
	BPT-6010-7643-WT	White	60.00	10.00	15.08	1	750	BBP12	R6000HF
	BPT-6010-7643-YL	Yellow	60.00	10.00	15.08	1	750	BBP12	R6000HF
	BPT-6010-7643-GN	Green	60.00	10.00	15.08	1	750	BBP12	R6000HF
	BPT-6010-7643-RD	Red	60.00	10.00	15.08	1	750	BBP12	R6000HF
	BPT-6010-7643-OR	Orange	60.00	10.00	15.08	1	750	BBP12	R6000HF
	BPT-6010-7643-BK	Black	60.00	10.00	15.08	1	750	BBP12	R4400-WT
	BPT-6010-7643-BL	Blue	60.00	10.00	15.08	1	750	BBP12	R6000HF
	BPT-7510-7643-WT	White	75.00	10.00	15.08	1	750	BBP12	R6000HF
	BPT-7510-7643-YL	Yellow	75.00	10.00	15.08	1	750	BBP12	R6000HF
	BPT-7510-7643-GN	Green	75.00	10.00	15.08	1	750	BBP12	R6000HF
	BPT-7510-7643-RD	Red	75.00	10.00	15.08	1	750	BBP12	R6000HF
	BPT-7510-7643-OR	Orange	75.00	10.00	15.08	1	750	BBP12	R6000HF
	BPT-7510-7643-BK	Black	75.00	10.00	15.08	1	750	BBP12	R4400-WT
	BPT-7510-7643-BL	Blue	75.00	10.00	15.08	1	750	BBP12	R6000HF
	BPT-7515-7643-WT	White	75.00	15.00	20.02	1	500	BBP12	R6000HF
	BPT-7515-7643-YL	Yellow	75.00	15.00	20.02	1	500	BBP12	R6000HF
	BPT-7515-7643-GN	Green	75.00	15.00	20.02	1	500	BBP12	R6000HF
	BPT-7515-7643-RD	Red	75.00	15.00	20.02	1	500	BBP12	R6000HF
	BPT-7515-7643-OR	Orange	75.00	15.00	20.02	1	500	BBP12	R6000HF
	BPT-7515-7643-BK	Black	75.00	15.00	20.02	1	500	BBP12	R4400-WT
	BPT-7515-7643-BL	Blue	75.00	15.00	20.02	1	500	BBP12	R6000HF
	BPT-7525-7643-WT	White	75.00	25.00	30.16	1	250	BBP12	R6000HF
	BPT-7525-7643-YL	Yellow	75.00	25.00	30.16	1	250	BBP12	R6000HF
	BPT-7525-7643-GN	Green	75.00	25.00	30.16	1	250	BBP12	R6000HF
	BPT-7525-7643-RD	Red	75.00	25.00	30.16	1	250	BBP12	R6000HF
	BPT-7525-7643-OR	Orange	75.00	25.00	30.16	1	250	BBP12	R6000HF
	BPT-7525-7643-BK	Black	75.00	25.00	30.16	1	250	BBP12	R4400-WT
	BPT-7525-7643-BL	Blue	75.00	25.00	30.16	1	250	BBP12	R6000HF



B-7644 Laminat carriers

Colour: Yellow

Laminat Carriers come with a strip to laminate text labels. The carrier is to be fixed with two cable ties directly on the cables and wires. This dependable marking system enables you to permanently mark cables and wires. The Laminat carriers can be used for any type of cable identification where permanency of the legend is crucial.

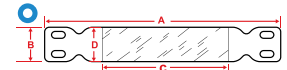

1. Pull the protective film backwards.



2. Place the label in the middle leaving space for sealing on all four sides of the label.



3. Seal the carrier by placing a finger on the film and pushing forward, thus rolling over the film and rolling off the silicon liner.



4. Always feed the cable ties from the top, thus bending down the Laminat carrier along the cable.

Diagram	Order Reference	Colour	Width A (mm)	Height B (mm)	Seal-up Area Width C (mm)	Seal-up Area Height D (mm)	Quantity / Package	Labels/Tapes Recommended
B-7644 : Polypropylene Tag with Polyester Overlaminat								
○	LC-65X13-B7644-0.1	Yellow	65.00	13.00	42.50	9.00	100	TH TTL-5-430/6 mm
○	LC-71X9-B7644-0.1	Yellow	70.99	9.00	45.00	9.00	100	TH TTL-5-430/6 mm
○	LC-103X15-B7644-0.1	Yellow	103.00	15.00	55.00	15.00	100	TH TTL-6-430/6 mm
○	LC-128X15-B7644	Yellow	128.00	15.00	80.00	15.00	100	TH TTL-1-430/9 mm
○	LC-178X15-B7644-0.05	Yellow	178.00	15.00	130.00	15.00	50	TH TTL-2-430/9 mm



B-7645 Laminat tags

Colour: Yellow

The Laminat tags (Manilla tags) are ideal for identification of material in tough environments including valves, instruments, motors and other industrial components.

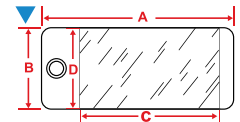

Diagram	Order Reference	Colour	Width A (mm)	Height B (mm)	Seal-up Area Width C (mm)	Seal-up Area Height D (mm)	Quantity / Package	Labels/Tapes Recommended
B-7645 : Polypropylene Tag with Polyester Overlaminat								
▼	LT-59X25-B7645-0.05	Yellow	59.00	25.00	43.00	25.00	50	TH TTL-4-430/9, 12, 19 mm
▼	LT-59X25-B7645-WR-0.05	Yellow	59.00	25.00	43.00	25.00	50	TH TTL-4-430/9, 12, 19 mm
▼	LT-150X25-B7645	Yellow	150.00	25.00	135.00	25.00	50	TH TTL-3-430/9, 12, 19 mm
▼	LT-150X25-B7645-WR-0.05	Yellow	150.00	25.00	135.00	25.00	50	TH TTL-3-430/9, 12, 19 mm



B-430 Labels for Laminat carriers and tags

Colour: Transparent

Finish: Gloss

Clear polyester labels specifically designed to fit the Laminat carriers and tags.

Performance attributes

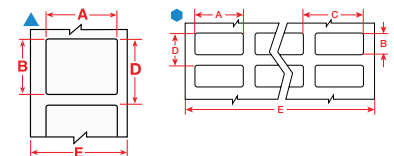

Diagram	Order Reference	Colour	Label Width A (mm)	Label Height B (mm)	Label Length B (m)	Vertical Repeat D (mm)	Web Width E (mm)	Labels per Row	Labels per Roll	Printer Compatibility	Ribbon Series
B-430 : Polyester											
●	TH TTL-1-430	Transparent	11.00	74.00	–	76.99	79.00	5	5000	BBP12, i7100, i5100	R6000HF
●	TH TTL-2-430	Transparent	11.00	124.00	–	127.00	79.00	5	5000	BBP12, i7100, i5100	R6000HF
●	TH TTL-3-430	Transparent	21.00	129.00	–	133.35	81.00	3	3000	BBP12, i7100, i5100	R6000HF
●	TH TTL-4-430	Transparent	37.00	21.00	–	24.25	88.90	2	2000	BBP12, i7100, i5100	R6000HF
▲	TH TTL-5-430	Transparent	39.00	5.08	–	7.94	51.00	1	1000	BBP12, i7100, i5100	R6000HF
▲	TH TTL-6-430	Transparent	49.00	11.10	–	14.11	60.96	1	1000	BBP12, i7100, i5100	R6000HF

B-348 Mass transit cable tag

Colour: White and Yellow

Finish: Matt

The B-348 Mass Transit Tag complies with minimal smoke and halogen emission requirements of the most strict underground norms for mass transit vehicles. The tag is a practical solution for mass transit manufacturers to identify thick cables and cable bundles.

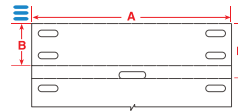

Diagram	Order Reference	Colour	Label Width A (mm)	Label Height B (mm)	Vertical Repeat D (mm)	Labels per Row	Labels per Package	Printer Compatibility	Ribbon Series	
B-348 : Polyolefin										
	THT-6010-348-WT	White	60.00	10.00	15.08	1	750	i7100, i5100	R6000HF	
	THT-6010-348-YL	Yellow	60.00	10.00	15.08	1	750	i7100, i5100	R6000HF	
	THT-7510-348-WT	White	75.00	10.00	15.08	1	750	i7100, i5100	R6000HF	
	THT-7510-348-YL	Yellow	75.00	10.00	15.08	1	750	i7100, i5100	R6000HF	
	THT-7515-348-WT	White	75.00	15.00	20.02	1	500	i7100, i5100	R6000HF	
	THT-7515-348-YL	Yellow	75.00	15.00	20.02	1	500	i7100, i5100	R6000HF	
	THT-7525-348-WT	White	75.00	25.00	30.16	1	250	i7100, i5100	R6000HF	
	THT-7525-348-YL	Yellow	75.00	25.00	30.16	1	250	i7100, i5100	R6000HF	
Following part numbers are mounted on a 25 mm diameter core and do not require the unwider for use with the BBP12 Printer.										
	BPT-6010-348-WT	White	60.00	10.00	15.08	1	750	BBP12	R6000HF	
	BPT-6010-348-YL	Yellow	60.00	10.00	15.08	1	750	BBP12	R6000HF	
	BPT-7510-348-WT	White	75.00	10.00	15.08	1	750	BBP12	R6000HF	
	BPT-7510-348-YL	Yellow	75.00	10.00	15.08	1	750	BBP12	R6000HF	
	BPT-7515-348-WT	White	75.00	15.00	20.02	1	500	BBP12	R6000HF	
	BPT-7515-348-YL	Yellow	75.00	15.00	20.02	1	500	BBP12	R6000HF	
	BPT-7525-348-WT	White	75.00	25.00	30.16	1	250	BBP12	R6000HF	
	BPT-7525-348-YL	Yellow	75.00	25.00	30.16	1	250	BBP12	R6000HF	

B-338 High temperature aerospace tag

Colour: White

Finish: Matt

- non-adhesive, rigid polyvinylidene fluoride cable tag
- easy to apply to thick cables, cable bundles or any cable post termination with cable ties
- meets RW-2513 standard on industrial and military fluids resistance, flame retardant and abrasion resistant
- resists temperatures between -55°C to 200°C
- great tear resistance
- low outgassing value

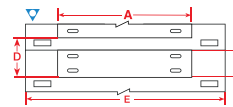

Diagram	Order Reference	Colour	Label Width A (mm)	Label Height B (mm)	Vertical Repeat D (mm)	Web Width E (mm)	Labels per Row	Labels per Roll	Printer Compatibility	Ribbon Series
B-338 : Polyvinylidene Fluoride										
	HSCMHT-410-2-WT	White	51.44	10.42	15.88	76.20	1	1500	i5100, i7100	R6000HF
	HSCMHT-800-2-WT	White	51.44	20.58	25.40	76.20	1	1000	i5100, i7100	R6000HF

B-388 Standard temperature aerospace tag

Colour: White and Yellow

Finish: Matt

- non-adhesive, rigid polyolefin cable tag
- easy to apply to thick cables, cable bundles or any cable post termination with cable ties
- meets RW-2513 standard on industrial and military fluids resistance, flame retardant and abrasion resistant
- resist temperatures between -55°C and 135°C

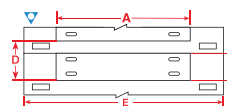
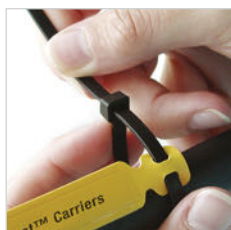
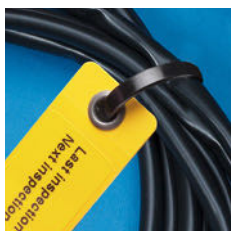

Diagram	Order Reference	Colour	Label Width A (mm)	Label Height B (mm)	Vertical Repeat D (mm)	Web Width E (mm)	Labels per Row	Labels per Roll	Printer Compatibility	Ribbon Series
B-388 : Polyolefin										
	HSCMST-410-2-WT	White	51.44	10.42	15.50	76.20	1	1500	i5100, i7100	R6000HF, R6600
	HSCMST-410-2-YL	Yellow	51.44	10.42	15.50	76.20	1	1500	i5100, i7100	R6000HF, R6600
	HSCMST-800-2-WT	White	51.44	20.32	25.40	76.20	1	1000	i5100, i7100	R6000HF, R6600
	HSCMST-800-2-YL	Yellow	51.44	20.32	25.40	76.20	1	1000	i5100, i7100	R6000HF, R6600



Coloured nylon wire and cable ties

Perfect for colour coded applications.



Black

Order Ref.	Colour	Width (mm)	Length (m)	Quantity
NYTIE-2.2x75-BK	Black	2.20	75.00	100
NYTIE-2.5x135-BK	Black	2.50	135.00	100
NYTIE-2.5x98-BK	Black	2.50	98.00	100
NYTIE-2.6x160-BK	Black	2.60	160.00	100
NYTIE-2.6x200-BK	Black	2.60	200.00	100
NYTIE-3.5x140-BK	Black	3.50	140.00	100
NYTIE-3.5x200-BK	Black	3.50	200.00	100
NYTIE-3.5x290-BK	Black	3.50	290.00	100
NYTIE-3.5x370-BK	Black	3.50	370.00	100
NYTIE-4.5x200-BK	Black	4.50	200.00	100
NYTIE-4.5x160-BK	Black	4.50	160.00	100
NYTIE-4.5x290-BK	Black	4.50	290.00	100
NYTIE-4.5x360-BK	Black	4.50	360.00	100
NYTIE-4.5x430-BK	Black	4.50	430.00	100
NYTIE-4.8x178-BK	Black	4.80	178.00	100
NYTIE-4.8x250-BK	Black	4.80	250.00	100
NYTIE-4.8x390-BK	Black	4.80	390.00	100
NYTIE-7.5x750-BK	Black	7.50	750.00	100
NYTIE-7.5x365-BK	Black	7.50	365.00	100
NYTIE-7.5x450-BK	Black	7.50	450.00	100
NYTIE-7.5x540-BK	Black	7.50	540.00	100
NYTIE-7.8x240-BK	Black	7.80	240.00	100
NYTIE-7.8x300-BK	Black	7.80	300.00	100
NYTIE-9x780-BK	Black	9.00	780.00	100
NYTIE-12.5x500-BK	Black	12.50	500.00	50
NYTIE-12.5x720-BK	Black	12.50	720.00	50
NYTIE-12.5x850-BK	Black	12.50	850.00	50

Natural

Order Ref.	Colour	Width (mm)	Length (m)	Quantity
NYTIE-2.5x135-NT	White	2.50	135.00	100
NYTIE-2.5x98-NT	White	2.50	98.00	100
NYTIE-2.6x200-NT	White	2.60	200.00	100
NYTIE-2.6x160-NT	White	2.60	160.00	100
NYTIE-3.5x140-NT	White	3.50	140.00	100
NYTIE-3.5x200-NT	White	3.50	200.00	100
NYTIE-3.5x290-NT	White	3.50	290.00	100
NYTIE-3.5x370-NT	White	3.50	370.00	100
NYTIE-4.5x160-NT	White	4.50	160.00	100
NYTIE-4.5x290-NT	White	4.50	290.00	100
NYTIE-4.5x360-NT	White	4.50	360.00	100
NYTIE-4.5x430-NT	White	4.50	430.00	100
NYTIE-4.8x200-NT	White	4.80	200.00	100
NYTIE-4.8x178-NT	White	4.80	178.00	100
NYTIE-4.8x250-NT	White	4.80	250.00	100
NYTIE-4.8x390-NT	White	4.80	390.00	100
NYTIE-7.5x750-NT	White	7.50	750.00	100
NYTIE-7.5x365-NT	White	7.50	365.00	100
NYTIE-7.5x450-NT	White	7.50	450.00	100
NYTIE-7.5x540-NT	White	7.50	540.00	100
NYTIE-7.8x240-NT	White	7.80	240.00	100
NYTIE-7.8x300-NT	White	7.80	300.00	100
NYTIE-9x780-NT	White	9.00	780.00	100
NYTIE-12.5x1000-NT	White	12.50	1000.00	50
NYTIE-12.5x500-NT	White	12.50	500.00	50
NYTIE-12.5x850-NT	White	12.50	850.00	50

Blue

Order Ref.	Colour	Width (mm)	Length (m)	Quantity
NYTIE-3.6x140-BL	Blue	3.60	140.00	100
NYTIE-3.6x200-BL	Blue	3.60	200.00	100
NYTIE-4.8x200-BL	Blue	4.80	200.00	100
NYTIE-4.8x290-BL	Blue	4.80	290.00	100

Red

Order Ref.	Colour	Width (mm)	Length (m)	Quantity
NYTIE-3.6x140-RD	Red	3.60	140.00	100
NYTIE-3.6x200-RD	Red	3.60	200.00	100
NYTIE-4.8x200-RD	Red	4.80	200.00	100
NYTIE-4.8x290-RD	Red	4.80	290.00	100

Green

Order Ref.	Colour	Width (mm)	Length (m)	Quantity
NYTIE-3.6x140-GN	Green	3.60	140.00	100
NYTIE-3.6x200-GN	Green	3.60	200.00	100
NYTIE-4.8x200-GN	Green	4.80	200.00	100
NYTIE-4.8x290-GN	Green	4.80	290.00	100

Yellow

Order Ref.	Colour	Width (mm)	Length (m)	Quantity
NYTIE-3.5x200-YL	Yellow	3.50	200.00	100
NYTIE-3.6x140-YL	Yellow	3.60	140.00	100
NYTIE-4.8x200-YL	Yellow	4.80	200.00	100
NYTIE-4.8x290-YL	Yellow	4.80	290.00	100

Stainless steel wire and cable ties and tags

Stainless steel tags and ties provide the highest performance option available for identifying cables and wires in the harshest environments. This durable material can withstand heat, UV, humidity and salt fog. In addition, it offers excellent resistance to oil and harsh chemicals such as skydrol, motor oil and gasoline.

Stainless steel tags

Stainless steel cable tags are made out of stainless steel 316 and are resistant to aggressive environments and temperatures up to 920°C.

- Can be laser engraved or embossed with any standard text, including serialisation
- Available in various widths and heights
- Available in blank stock, or factory-customised versions

Stainless steel ties

Extremely durable cable ties are available in grade 316 for almost any aggressive environment.



Stainless steel tags

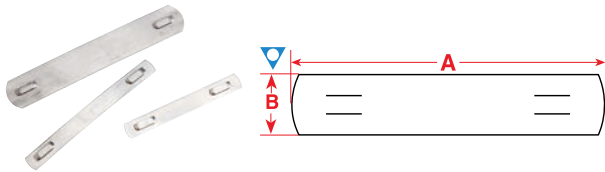

Diagram	Order Reference	Width (mm)	Height (mm)	Printable Area Width (mm)	Quantity / Package
Blank Stainless Steel Cable Tag - Stainless Steel Grade 316					
▽	SSTAG-7010-7316	70.00	10.00	50.04	100
▽	SSTAG-7013-7316	70.00	13.00	50.04	100
▽	SSTAG-9010-7316	89.99	10.00	70.10	100
▽	SSTAG-9013-7316	90.00	13.00	65.00	100
▽	SSTAG-11010-7316	110.01	10.00	80.01	100
▽	SSTAG-11013-7316	110.01	13.00	80.01	100

Customs available on request

Stainless steel ties



Order Reference	Width (mm)	Length (mm)	Quantity / Package
Stainless Steel Cable Tie - Stainless Steel Grade 316			
SSTIE-127-7316	4.60	130.00	100
SSTIE-201-7316	4.60	201.00	100
SSTIE-300-7316	4.60	300.00	100
SSTIE-370-7316	4.60	370.00	100
SSTIE-520-7316	4.60	520.00	100
SSTIE-300-7316-HD	7.90	300.00	100
SSTIE-370-7316-HD	7.90	370.00	100
SSTIE-520-7316-HD	7.90	520.00	100
SSTIE-840-7316-HD	7.90	840.00	100
Stainless Steel Coated Cable Tie - Stainless Steel Grade 316			
SSTIEC-201-7316	4.60	201.00	100
SSTIEC-370-7316	4.60	370.00	100
SSTIEC-201-7316-HD	7.90	201.00	100

Suffix HD refers to ties 7.9 mm wide.

Cable tie tools



Order Reference	Description	Quantity / Package
JV-4580	Heavy Duty Stainless Steel Cable Tie Tool	1
JV-4580MG	Cable Tie Tool with Heavy Duty Teeth	1

DuraSleeve wire marker

The DuraSleeve markers consist of two components: a transparent tube (carrier) with a label pocket and an insert to slide into the pocket. Your text is at all times protected by the tube and can easily be replaced. Print the inserts on a Brady printer to ensure clean crisp readable legends every time.

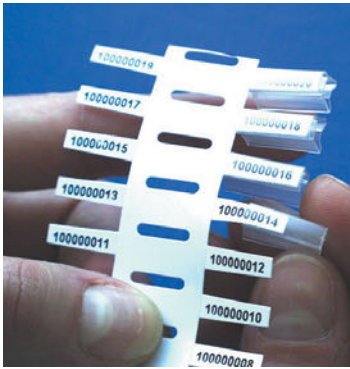

B-7696 DuraSleeve Vinyl tag material

Colour: White, Yellow

Finish: Gloss

Brady DuraSleeve printable inserts create a durable legend. The rigid construction of the DuraSleeve wire marking system provides inserts that can easily be inserted into a clean carrier. The legend can be changed before or after termination.

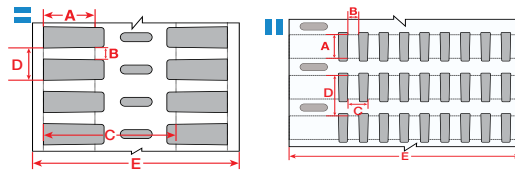

Diagram	Order Reference	Colour	Label Width A (mm)	Label Height B (mm)	Vertical Repeat D (mm)	Web Width E (mm)	Labels per Row	Labels per Package	Printer Compatibility	Ribbon Series
B-7696 : Vinyl										
II	THTRDS-10x4,4-7696	White	10.00	4.40	16.93	84.60	8	8000	BBP12, i7100	R6000HF, R7964
II	THTRDS-12x4,4-7696	White	12.00	4.40	18.14	84.17	8	8000	BBP12, i7100	R6000HF, R7964
II	THTRDS-16x4,4-7696	White	16.00	4.40	22.22	84.17	8	6000	BBP12, i7100	R6000HF, R7964
II	THTRDS-16x4,4-7696-YL	Yellow	16.00	4.40	22.22	84.17	8	10000	BBP12, i7100	R6000HF, R7964
II	THTRDS-23x4,4-7696	White	23.00	4.40	29.21	84.17	8	4000	BBP12, i7100	R6000HF, R7964
II	THTRDS-30x4,4-7696	White	30.00	4.40	36.11	84.17	8	4000	BBP12, i7100	R6000HF, R7964
II	THTRDS-30x4,4-7696-YL	Yellow	30.00	4.40	36.11	84.17	8	10000	BBP12, i7100	R6000HF, R7964
Following part numbers are mounted on a 25 mm diameter core and do not require the unwider for use with the BBP12 Printer.										
III	BPTRDS-16x4,4-7696	White	16.00	4.40	10.92	68.00	2	5000	BBP12	R6000HF, R7964
III	BPTRDS-16x4,4-7696-YL	Yellow	16.00	4.40	10.92	68.00	2	5000	BBP12	R6000HF, R7964
III	BPTRDS-30x4,4-7696	White	30.63	4.40	10.92	96.00	2	5000	BBP12	R6000HF, R7964
III	BPTRDS-30x4,4-7696-YL	Yellow	30.63	4.40	10.92	96.00	2	5000	BBP12	R6000HF, R7964



DuraSleeve Tag carrier

DuraSleeve tag carriers are produced in transparent PVC. The special shape of the carrier allows it to adapt to cables of various diameters. There are several sizes of carriers which cater for cables with external diameters from 1.30 mm up to 15 mm.

- Temperature range: -40 °C to 60 °C
- Material: PVC

Please contact your local Brady representative to identify and select the most appropriate carrier for your individual application.



Pre-printed wire markers materials chart

Brady's exclusive ZipStrip® release card lets you easily remove the markers you need, when you need them.

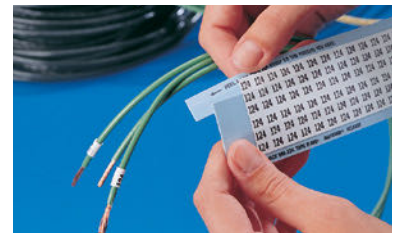

Brady Material No.	Material	Temp (°C) (Tested for 30 days)	Colour	Finish	Use	Additional Information
B-12	Acetate Cloth	105 °C	Black on White	Matt	Wire marker for varnish dip or baking cycles	Oil and heat resistant
B-184	Aluminium Foil	130 °C	Black on Silver	Matt	Permanent debossed marking	Heat, oil, solvent and abrasion resistant
B-292	Self-laminating Vinyl	70 °C	Black on White	Matt	Machine tool, flat ribbon, and wire marking	Conformable, durable; oil, water and mild solvent resistant
B-500	Vinyl Cloth	80 °C	Black on White	Matt	All-purpose marker	Moderate heat, oil and dirt resistance; high adhesion
B-702	Vinyl	100 °C	Black on White	Gloss	Vinyl coated; machine tool labelling	Oil and mild solvent resistant; high adhesion
B-708	Vinyl	70 °C	Black on White	Semi-gloss	Indoor/Outdoor cable marking	Conformable, durable; oil, water and mild solvent resistant; self-laminating

Reference explanation

Most Brady references for pre-printed wire markers follow the same format: The first code indicates the Brady product, the second legend indicates the marker's legend and a third code indicates a package of 25 cards.

WM - **5** - **PK**
Brady - **Legend reads** - **Quantity**
Wire Marker Card - **"5"**

Wire marker cards

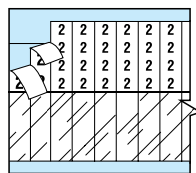
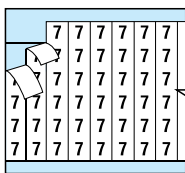

Solid numbers

Legend	B-500 Vinyl Cloth	B-702 Vinyl	B-184 Aluminium Foil	B-12 Acetate Cloth	Width (mm)	Height (mm)	Labels/ Card
0	WM-0-PK	TWM-0-PK	AF-0-PK		6.35	38.10	36
1	WM-1-PK	TWM-1-PK	AF-1-PK	HH-1-PK	6.35	38.10	36
2	WM-2-PK	TWM-2-PK	AF-2-PK	HH-2-PK	6.35	38.10	36
and so on through	and so on through	and so on through	and so on through	and so on through	6.35	38.10	36
11	WM-11-PK	TWM-11-PK	AF-11-PK	HH-9-PK	6.35	38.10	36
12	WM-12-PK		AF-12-PK		6.35	38.10	36
and so on through	and so on through		and so on through		6.35	38.10	36
50	WM-50-PK		AF-15-PK		6.35	38.10	36
and so on through	and so on through				6.35	38.10	36
125	WM-125-PK				9.14	38.10	25

38 mm suitable for cable diameter < 12 mm - 36 markers/card up to No.99 and 25 markers/card from No. 100 onwards - pack contains 25 cards

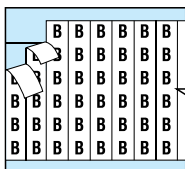

Solid letters - upper case

Legend	B-500 Vinyl Cloth	B-184 Aluminium Foil	Width (mm)	Height (mm)	Labels/ Card
A	WM-A-PK	AF-A-PK	6.35	38.10	36
B	WM-B-PK	AF-B-PK	6.35	38.10	36
C	WM-C-PK	AF-C-PK	6.35	38.10	36
and so on through	and so on through	and so on through	6.35	38.10	36
Z	WM-Z-PK	AF-Z-PK	6.35	38.10	36

38 mm suitable for cable diameter < 12 mm - pack contains 25 cards

Wire marker cards

Solid numbers on coloured background

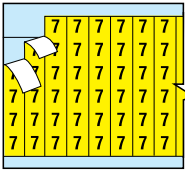

Legend	White on Red	Black on Yellow	Black on Blue	White on Green	Width (mm)	Height (mm)	Labels/Card
B-500 Vinyl Cloth							
0	WM-0-RD-PK	WM-0-YL-PK	WM-0-BL-PK		6.35	38.10	36
1	WM-1-RD-PK	WM-1-YL-PK	WM-1-BL-PK	WM-1-GR-PK	6.35	38.10	36
2	WM-2-RD-PK	WM-2-YL-PK	WM-2-BL-PK	WM-2-GR-PK	6.35	38.10	36
3		WM-3-YL-PK		WM-3-GR-PK	6.35	38.10	36
4		WM-4-YL-PK		WM-4-GR-PK	6.35	38.10	36
5		WM-5-YL-PK		WM-5-GR-PK	6.35	38.10	36
and so on through		and so on through			6.35	38.10	36
30		WM-30-YL-PK			6.35	38.10	36

38 mm suitable for cable diameter < 12 mm - pack contains 25 cards

Consecutive numbers and self-laminating consecutive numbers

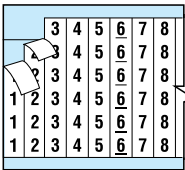

Legend	B-500 Vinyl Cloth	B-702 Vinyl	B-184 Aluminium Foil	B-12 Acetate Cloth	B-292 Self-laminating Vinyl	Width (mm)	Height (mm)	Labels/Card
1-33	WM-1-33-PK	TWM-1-33-PK	AF-1-33-PK	HH-1-33-PK	SLF-1-33-PK	6.35	38.10	33
34-66	WM-34-66-PK	TWM-34-66-PK	AF-34-66-PK	HH-34-66-PK	SLF-34-66-PK	6.35	38.10	33
67-99	WM-67-99-PK	TWM-67-99-PK	AF-67-99-PK			6.86	38.10	33
100-124	WM-100-124-PK		AF-100-124-PK			19.05	38.00	25
125-149	WM-125-149-PK		AF-125-149-PK			9.14	38.10	25
and so on through	and so on through					9.14	38.10	25
200-224	WM-200-224-PK					9.14	38.10	25
and so on through	and so on through					9.14	38.10	25
875-899	WM-975-999-PK					9.14	38.10	25

38 mm suitable for cable diameter < 12 mm - pack contains 25 cards

Consecutive letters

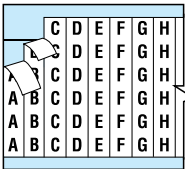

Legend	Art. No.	Width (mm)	Height (mm)	Labels/Card
B-500 Vinyl Cloth				
A-Z	WM-A-Z-PK	8.64	38.10	26
A-Z,A-J	WM-A-Z,A-J-PK	6.35	38.10	36

38 mm suitable for cable diameter < 12 mm - pack contains 25 cards

Consecutive numbers on coloured background

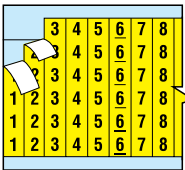

Legend	White on Red	Black on Yellow	Black on Orange	Black on Blue	Width (mm)	Height (mm)	Labels/Card
B-500 Vinyl Cloth							
1-33	WM-1-33-RD-PK	WM-1-33-YL-PK	WM-1-33-OR-PK	WM-1-33-BL-PK	6.35	38.10	33
34-66	WM-34-66-RD-PK	WM-34-66-YL-PK	WM-34-66-OR-PK	WM-34-66-BL-PK	6.35	38.10	33
67-99	WM-67-99-RD-PK	WM-67-99-YL-PK	WM-67-99-OR-PK		6.86	38.10	33
100-124	WM-100-124-RD-PK	WM-100-124-YL-PK			9.14	38.10	25

Legend	White on Green	White on Brown	White on Black	Width (mm)	Height (mm)	Labels/Card
B-500 Vinyl Cloth						
1-33	WM-1-33-GR-PK	WM-1-33-BR-PK	WM-1-33-BK-PK	6.35	38.10	33
34-66	WM-34-66-GR-PK	WM-34-66-BR-PK	WM-34-66-BK-PK	6.35	38.10	33
67-99	WM-67-99-GR-PK	WM-67-99-BR-PK	WM-67-99-BK-PK	6.86	38.10	33
100-124			WM-100-124-BK-PK	9.14	38.10	25

38 mm suitable for cable diameter < 12 mm - pack contains 25 cards

Consecutive letters on coloured background

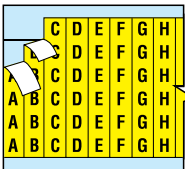

Legend	Black on Yellow	Width (mm)	Height (mm)	Labels/Card
B-500 Vinyl Cloth				
A-Z	WM-A-Z-YL-PK	8.64	38.10	26

38 mm suitable for cable diameter < 12 mm - pack contains 25 cards

Wire marker cards

Consecutive numbers repeated

Legend	Art. No.	Width (mm)	Height (mm)	Sequences per Card	Labels/ Card
B-500 Vinyl Cloth					
1-3	WM-1-3-PK	6.35	38.10	12	36
1-4	WM-1-4-PK	6.35	38.10	9	36
1-6	WM-1-6-PK	6.35	38.10	6	36
1-8	WM-1-8-PK	6.35	38.10	4	32
1-9	WM-1-9-PK	6.35	38.10	4	36
0-9	WM-0-9-PK	6.35	38.10	3	30
1-10	WM-1-10-PK	6.86	38.10	3	30
0-10	WM-0-10-PK	6.35	38.10	3	33
1-12	WM-1-12-PK	6.35	38.10	3	36
1-16	WM-1-16-PK	6.86	38.10	2	32
1-18	WM-1-18-PK	6.35	38.10	2	36
19-36	WM-19-36-PK	6.35	38.10	2	36
B-184 Aluminium Foil					
1-18	AF-1-18-PK	6.35	38.10	2	36

38 mm suitable for cable diameter < 12 mm - pack contains 25 cards

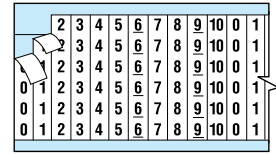

Consecutive paired numbers

Use to mark both ends of wire with the same legend, fast and easy from the same dispenser card.

Legend	Art. No.	Width (mm)	Height (mm)	Sequences per Card	Labels/ Card
B-500 Vinyl Cloth					
1-16	WM-1-16-DC-PK	6.86	38.10	2	32
17-32	WM-17-32-DC-PK	6.35	38.10	2	32

38 mm suitable for cable diameter < 12 mm - pack contains 25 cards

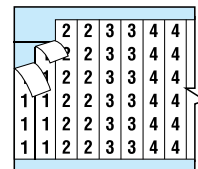

Suffix numbers

Use to extend numbering codes or to make up other combinations of numbers or alpha-numeric codes.

Legend	Art. No.	Width (mm)	Height (mm)	Labels/Card
B-500 Vinyl Cloth				
00	WM-00-S-PK	6.35	38.10	36
and so on through				
09	WM-09-S-PK	6.35	38.10	36

38 mm suitable for cable diameter < 12 mm - pack contains 25 cards

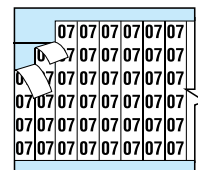

Solid NEMA colours

Colour	B-500 Vinyl Cloth	B-702 Vinyl	Width (mm)	Height (mm)	Labels/Card
Red	WM-COL-RD-PK	TWM-COL-RD-PK	6.35	38.10	36
Yellow	WM-COL-YL-PK	TWM-COL-YL-PK	6.35	38.10	36
Light Blue	WM-COL-LB-PK	TWM-COL-LB-PK	6.35	38.10	36
Dark Blue	WM-COL-DB-PK	TWM-COL-DB-PK	6.35	38.10	36
Light Green	WM-COL-LG-PK	TWM-COL-LG-PK	6.35	38.10	36
Dark Green	WM-COL-DG-PK	TWM-COL-DG-PK	6.35	38.10	36
White	WM-COL-WT-PK	TWM-COL-WT-PK	6.35	38.10	36
Black	WM-COL-BK-PK	TWM-COL-BK-PK	6.35	38.10	36
Tan	WM-COL-TN-PK	TWM-COL-TN-PK	6.35	38.10	36
Brown	WM-COL-BR-PK	TWM-COL-BR-PK	6.35	38.10	36
Orange	WM-COL-OR-PK	TWM-COL-OR-PK	6.35	38.10	36
Pink	WM-COL-PK-PK	TWM-COL-PK-PK	6.35	38.10	36
Grey	WM-COL-GY-PK	TWM-COL-GY-PK	6.35	38.10	36
Maroon	WM-COL-MR-PK	TWM-COL-MR-PK	6.35	38.10	36
Purple	WM-COL-PL-PK	TWM-COL-PL-PK	6.35	38.10	36

38 mm suitable for cable diameter < 12 mm - pack contains 25 cards

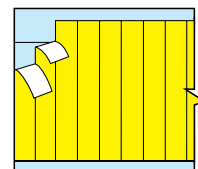

Self-laminating write-on wire markers

Art. No.	Width (mm)	Height (mm)	Write-on Area Width (mm)	Write-on Area Height (mm)	Labels/ Card
B-292 Self-laminating Vinyl					
SLHW-250-PK	6.35	19.05	6.35	9.53	72
SLHW-500-PK	12.70	19.05	12.70	9.53	36
SLHW-750-PK	19.05	19.05	19.05	9.53	24
SFLW-250	6.35	38.10	6.35	19.05	36
SFLW-344	8.64	38.10	8.74	19.05	26
SFLW-500	12.70	38.10	12.70	19.05	18
SFLW-750	19.05	38.10	19.05	19.05	12
SFLW-100	25.40	38.10	25.40	19.05	9

19 mm suitable for cable diameter 4 to 6.5 and 38 mm suitable for cable diameter < 12 mm - pack contains 25 cards

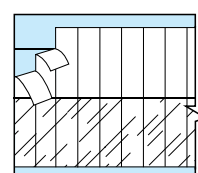

Wire marker cards

Solid letters and numbers - Conduit markers

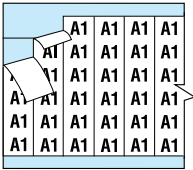

Legend	Art. No.	Width (mm)	Height (mm)	Labels/Card
B-500 Vinyl Cloth				
A1	WM-A1-PK	6.35	38.10	36
A2	WM-A2-PK	6.35	38.10	36
A3	WM-A3-PK	6.35	38.10	36
L1	WM-L1-PK	6.35	38.10	36
L2	WM-L2-PK	6.35	38.10	36
L3	WM-L3-PK	6.35	38.10	36
T1	WM-T1-PK	6.35	38.10	36
T2	WM-T2-PK	6.35	38.10	36

38 mm suitable for cable diameter < 12 mm - Pack contains 25 cards

Solid symbols - Miscellaneous

Legend	Art. No.	Width (mm)	Height (mm)	Labels/Card
B-500 Vinyl Cloth				
24V	WM-24V-PK	9.14	38.10	25
"Ground Symbol"	WM-GRS-PK	6.35	38.10	36
-	WM-MIN-PK	6.35	38.10	36
+	WM-PLS-PK	6.35	38.10	36
B-702 Vinyl				
-	TWM-MIN-PK	6.35	38.10	36
+	TWM-PLS-PK	6.35	38.10	36

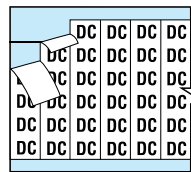

38 mm suitable for cable diameter < 12 mm - Pack contains 25 cards

Terminal markers

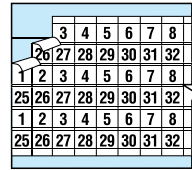

Legend	Art. No.	Width (mm)	Height (mm)	Labels/Card
B-500 Vinyl Cloth				
1-48	WM-1-48-TM-PK	7.87	4.83	144
49-96	WM-49-96-TM-PK	7.87	4.83	144
A-Z	WM-A-Z-TM-PK	7.87	4.83	156

Terminal markers have no "I" or "O" - 38 mm suitable for cable diameter < 12 mm
- Pack contains 25 cards

Cable marker cards

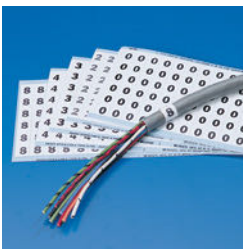

Standard 101.6 mm x 228.6 mm cards provide markers for cables, multi-wire circuits, even conductors and tubing in hydraulic systems. Markers are 89 mm long.

Solid numbers

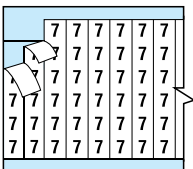

Legend	Art. No.	Width (mm)	Height (mm)	Labels/Card
B-708 Vinyl				
1	CAB-1-PK	12.70	88.90	18
2	CAB-2-PK	12.70	88.90	18
3	CAB-3-PK	12.70	88.90	18
4	CAB-4-PK	12.70	88.90	18
5	CAB-5-PK	12.70	88.90	18
6	CAB-6-PK	12.70	88.90	18
7	CAB-7-PK	12.70	88.90	18
8	CAB-8-PK	12.70	88.90	18
9	CAB-9-PK	12.70	88.90	18

Pack contains 25 cards

Consecutive numbers

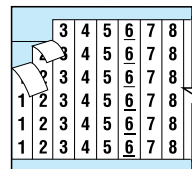

Legend	Art. No.	Width (mm)	Height (mm)	Labels/Card
B-708 Vinyl				
1-9	CAB-1-9-PK	12.70	88.90	18

Two sets of legends per card - Pack contains 25 cards

Miniature wire marker cards

Solid numbers, solid letters

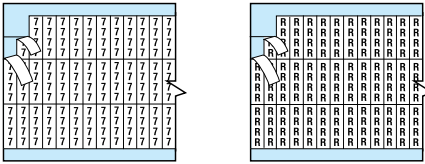

Legend	Art. No.	Width (mm)	Height (mm)	Labels/ Card
B-702 Vinyl				
1	TMM-1-PK	4.57	12.70	150
2	TMM-2-PK	4.57	12.70	150
3	TMM-3-PK	4.57	12.70	150
and so on through	and so on through	–	–	–
40	TMM-40-PK	4.57	12.70	150
A	TMM-A-PK	4.57	12.70	150
B	TMM-B-PK	4.57	12.70	150
C	TMM-C-PK	4.57	12.70	150
and so on through	and so on through	–	–	–
Z	TMM-Z-PK	4.57	12.70	150

Pack contains 25 cards

Consecutive numbers

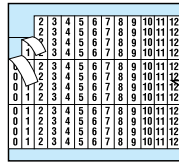

Legend	Art. No.	Width (mm)	Height (mm)	Quantity of Each Number per Card	Labels/ Card
B-702 Vinyl					
0-49	TMM-0-49-PK	4.57	12.70	3	150
50-99	TMM-50-99-PK	4.57	12.70	3	150
100-132	TMM-100-132-PK	6.86	12.70	3	99
133-165	TMM-133-165-PK	6.86	12.70	3	99
166-198	TMM-166-198-PK	6.86	12.70	3	99
331-363	TMM-331-363-PK	6.86	12.70	3	99
364-396	TMM-364-396-PK	6.86	12.70	3	99

Pack contains 25 cards

Solid NEMA colours

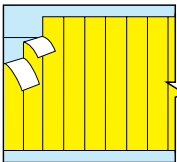

Colour	Art. No.	Width (mm)	Height (mm)	Labels/Card
B-702 Vinyl				
Red	TMM-COL-RD-PK	6.35	12.70	108
Yellow	TMM-COL-YL-PK	6.35	12.70	108
Light Blue	TMM-COL-LB-PK	6.35	12.70	108
Light Green	TMM-COL-LG-PK	6.35	12.70	108
Dark Green	TMM-COL-DG-PK	6.35	12.70	108
White	TMM-COL-WT-PK	6.35	12.70	108
Black	TMM-COL-BK-PK	6.35	12.70	108
Brown	TMM-COL-BR-PK	6.35	12.70	108
Orange	TMM-COL-OR-PK	6.35	12.70	108
Pink	TMM-COL-PK-PK	6.35	12.70	108
Grey	TMM-COL-GY-PK	6.35	12.70	108
Purple	TMM-COL-PL-PK	6.35	12.70	108

Pack contains 25 cards

Micro marker cards

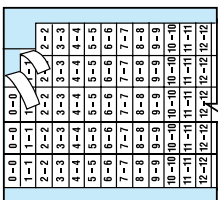

For identification of fine wire (Diameter 0.6 mm and smaller); resists continuous heat to 100° C. Only 56 micron thick. Two numbers on each marker, 250 markers on zip-strip dispenser card. Application tool included in each package.

Solid numbers

Legend	Art. No.	Width (mm)	Height (mm)	Labels/ Card
B-702 Vinyl				
1	TMXM-1-PK	7.95	2.38	250
2	TMXM-2-PK	7.95	2.38	250
3	TMXM-3-PK	7.95	2.38	250
5	TMXM-5-PK	7.95	2.38	250
and so on through	and so on through	–	–	–
13	TMXM-13-PK	7.95	2.38	250

Pack contains 25 cards

Consecutive numbers repeated

Legend	Art. No.	Width (mm)	Height (mm)	Sequences per Card	Labels/ Card
B-702 Vinyl					
0-49	TMXM-0-49-PK	7.95	2.38	5	250
50-99	TMXM-50-99-PK	7.95	2.38	5	250
1-5	TMXM-1-5-PK	7.95	2.38	50	250
1-10	TMXM-1-10-PK	7.95	2.38	25	250
1-25	TMXM-1-25-PK	7.95	2.38	10	250

Pack contains 25 cards

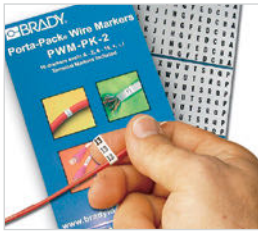

Porta Pack books

- Ten pages per book.
- Unique comb design allows for easy refill of book.
- Slim, lightweight, pocket-sized book is easy to carry and easy to use.
- Large selection of legends available. 15 different books and over 250 different refill packs.
- Numbers, letters, special symbols and NEMA colours.
- Includes terminal marker with each wire marker.

Legend	Art. No.	Width (mm)	Height (mm)	Markers each legend
B-500 Vinyl Cloth				
0-9	PWM-PK-1	5.50	39.70	45 markers of each legend
A-Z, 0-15, +, -, /	PWM-PK-2	5.50	39.70	10 markers of each legend
1-45	PWM-PK-3	5.50	39.70	10 markers of each legend
1, 2, 3	PWM-PK-4	5.50	39.70	150 markers each 1, 2, 3
A, B, C	PWM-PK-5	5.50	39.70	150 markers each A, B, C
L1, L2, L3	PWM-PK-7	5.50	39.70	150 markers each L1, L2, L3
1-15, 16-90, A-Z, +, -, /, 0	PWM-PK-8	5.50	39.70	6 markers 1-15 4 markers 16-90 2 markers A-Z, +, -, /, 0
1, 2, 3, A, B, C, T1, T2, T3, L1, L2, L3	PWM-PK-9	5.50	39.70	45 markers each 1, 2, 3, A, B, C 30 markers each T1, T2, T3, L1, L2, L3
1-30	PWM-PK-11	5.50	39.70	15 markers of each legend
A-Z, Blank, +, -	PWM-PK-12	5.50	39.70	15 markers A to Z 18 blank write-on markers 8 markers of + 7 markers of -
+, -, AC, DC, POS, NEG, GND, NEUT, SPARE, BLANK	PWM-PK-13	5.50	39.70	45 markers each of +, -, AC, DC 33 markers each of POS, NEG, GND, NEUT 21 markers each Spare 21 markers each Blank Write-On Labels
46-90	PWM-PK-14	5.50	39.70	10 markers of each legend
1-45, 46-90	PWM-PK-15	5.50	39.70	5 markers of each legend

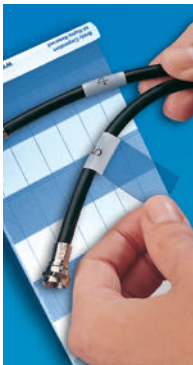

Write-on self-laminating wire and cable markers

- Use Brady's labelling pens or other markers to write on legend.
- Transparent part over-wraps provide snug fitting, self-laminating shield that resists oil, water and solvents.
- For applications above or below ground.

Art. No.	Width (mm)	Height (mm)	Write-on Area Width (mm)	Write-on Area Height (mm)	Markers per Book
B-292 Self-laminating Vinyl					
PWC-PK-1	19.05	44.45	19.05	12.70	120
PWC-PK-3	25.40	76.20	25.40	19.05	60
PWC-PK-6	25.40	152.40	25.40	25.40	30
PWS-PK-14	12.70	38.10	12.70	19.05	180
PWC-PK-36*	25.40	57.15	25.40	25.40	45

*Book Supplied with 30 markers size 25.40 x 76.20 and 15 markers 25.40 x 152.40. 5 sheets with 6 markers + 5 sheets of 3 markers.

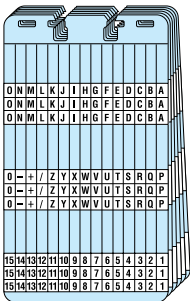

Self-laminating wire markers

- Ten pages per book.
- Same as above but with printed legends

Legend	Art. No.	Width (mm)	Height (mm)	Markers each legend	Markers per book
B-292 Self-laminating Vinyl					
0-9	PWS-PK-1	5.50	39.70	45	450
A-Z, 0-15, +, -, /	PWS-PK-2	5.50	39.70	10	450
1-45	PWS-PK-3	5.50	39.70	10	450

Labelling pens

Brady's labelling pens use a quick drying, permanent ink. The ink is specially formulated to resist oil, solvents, abrasion and fading.



Order Ref.	Colour	Description	Quantity
MP-1	Black	Pen - Fine (solvent based)	1
BFS-05	Black	Pen - Fine	5
BFS-10	Black	Pen - Ultra Fine	5

ClipSleeve wire markers

Sizes 03 to 18 are supplied on wands with 30 sleeves per wand, 10 wands to a package. Sizes larger than 18 are packed 50 individual pieces per package.

Combination packs: Prefix **SCNC** contains 10 wands, one wand each of numbers 0 to 9.

Alpha packs: Contains 13 wands, one wand each of A to M or N to Z. (e.g. SCN-07-A-M).

Note: Alpha packs are not available for SCN-03, -05, -23, -36, -45 or -61.

Applier wands: Separate wands for applying Size 23 and Size 36 ClipSleeve markers are available in packages of 5 wands. Specify SCN-23-WANDS for Size 23 and SCN-36-WANDS for Size 36.

- Markers apply quickly with a special QuikWand applicator.
- Place the flared shoe end of the wand against the wire and push sleeve onto the wire.
- Split sleeve with chevron locking design snaps on the wire, won't slip or slide.
- Colour coding aids users: Brady ClipSleeve applicator wands are colour coded for easy identification of sleeve sizes.



Preprinted black on white

Min/Max Wire Diameter (mm) Legend	1.00 - 1.30 Art. No.	1.40 - 1.80 Art. No.	1.90 - 2.40 Art. No.	2.50 - 3.00 Art. No.	2.80 - 3.30 Art. No.	3.40 - 3.80 Art. No.
0	SCN-03-0	SCN-05-0	SCN-07-0	SCN-09-0	SCN-10-0	SCN-13-0
and so on through	and so on through	and so on through	and so on through	and so on through	and so on through	and so on through
9	SCN-03-9	SCN-05-9	SCN-07-9	SCN-09-9	SCN-10-9	SCN-13-9
0-9	SCNC-03-0-9	SCNC-05-0-9	SCNC-07-0-9	SCNC-09-0-9	SCNC-10-0-9	SCNC-13-0-9
A	SCN-03-A	SCN-05-A	SCN-07-A	SCN-09-A	SCN-10-A	SCN-13-A
and so on through	and so on through	and so on through	and so on through	and so on through	and so on through	and so on through
Z	SCN-03-Z	SCN-05-Z	SCN-07-Z	SCN-09-Z	SCN-10-Z	SCN-13-Z
A-M			SCNC-07-A-M	SCNC-09-A-M	SCNC-10-A-M	SCNC-13-A-M
N-Z			SCNC-07-N-Z	SCNC-09-N-Z	SCNC-10-N-Z	SCNC-13-N-Z
+	SCN-03-PLUS	SCN-05-PLUS	SCN-07-PLUS	SCN-09-PLUS	SCN-10-PLUS	SCN-13-PLUS
-	SCN-03-MINUS	SCN-05-MINUS	SCN-07-MINUS	SCN-09-MINUS	SCN-10-MINUS	SCN-13-MINUS
/	SCN-03-DIAGONAL		SCN-07-DIAGONAL	SCN-09-DIAGONAL	SCN-10-DIAGONAL	SCN-13-DIAGONAL
Full Stop	SCN-03-PUNC		SCN-07-PUNC	SCN-09-PUNC	SCN-10-PUNC	SCN-13-PUNC
Earth/Ground Symbol	SCN-03-GRS	SCN-05-GRS		SCN-09-GRS	SCN-10-GRS	
Quantity / Package	300	300	300	300	300	300
Wand Colour	Maroon	Grey	Light Blue	Green	Red	Dark Blue

Min/Max Wire Diameter (mm) Legend	3.90 - 4.50 Art. No.	4.70 - 5.80 Art. No.	5.90 - 8.50 Art. No.	8.60 - 11.10 Art. No.	11.20 - 15.00 Art. No.	15.10 - 19.00 Art. No.
0	SCN-15-0	SCN-18-0	SCN-23-0	SCN-36-0	SCN-45-0	SCN-61-0
and so on through	and so on through	and so on through	and so on through	and so on through	and so on through	and so on through
9	SCN-15-9	SCN-18-9	SCN-23-9	SCN-36-9	SCN-45-9	SCN-61-9
0-9	SCNC-15-0-9	SCNC-18-0-9	SCNC-23-0-9			
A	SCN-15-A	SCN-18-A	SCN-23-A	SCN-36-A		
and so on through	and so on through	and so on through	and so on through	and so on through		
Z	SCN-15-Z	SCN-18-Z	SCN-23-Z	SCN-36-Z		
A-M	SCNC-15-A-M	SCNC-18-A-M				
N-Z	SCNC-15-N-Z	SCNC-18-N-Z				
+	SCN-15-PLUS	SCN-18-PLUS	SCN-23-PLUS	SCN-36-PLUS	SCN-45-PLUS	
-	SCN-15-MINUS	SCN-18-MINUS	SCN-23-MINUS			
/	SCN-15-DIAGONAL	SCN-18-DIAGONAL	SCN-23-DIAGONAL			
Full Stop	SCN-15-PUNC	SCN-18-PUNC		SCN-36-PUNC	SCN-45-PUNC	
Earth/Ground Symbol	SCN-15-GRS		SCN-23-GRS			
Quantity / Package	300	300	50	50	50	50
Wand Colour	Brown	Yellow				

Blank on coloured background

Min/Max Wire Diameter (mm) Colour	1.00 - 1.30 Art. No.	1.40 - 1.80 Art. No.	1.90 - 2.40 Art. No.	2.50 - 3.00 Art. No.	2.80 - 3.30 Art. No.	3.40 - 3.80 Art. No.
Black	SCN-03-BLACK	SCN-05-BLACK		SCN-09-BLACK	SCN-10-BLACK	
Blue	SCN-03-BLUE	SCN-05-BLUE	SCN-07-BLUE	SCN-09-BLUE	SCN-10-BLUE	
Green	SCN-03-GREEN	SCN-05-GREEN	SCN-07-GREEN	SCN-09-GREEN	SCN-10-GREEN	
Red	SCN-03-RED	SCN-05-RED	SCN-07-RED	SCN-09-RED	SCN-10-RED	
White	SCN-03-WHITE	SCN-05-BLANK	SCN-07-BLANK	SCN-09-BLANK	SCN-10-BLANK	SCN-13-BLANK
Yellow	SCN-03-YELLOW	SCN-05-YELLOW	SCN-07-YELLOW	SCN-09-YELLOW	SCN-10-YELLOW	SCN-13-YELLOW
Quantity / Package	300	300	300	300	300	300

Min/Max Wire Diameter (mm) Colour	3.90 - 4.50 Art. No.	4.70 - 5.80 Art. No.	5.90 - 8.50 Art. No.	8.60 - 11.10 Art. No.
Black	SCN-15-BLACK	SCN-18-BLACK		
Blue		SCN-18-BLUE		
Green		SCN-18-GREEN	SCN-23-GREEN	
Red	SCN-15-RED	SCN-18-RED	SCN-23-RED	
White		SCN-18-WHITE	SCN-23-BLANK	SCN-36-BLANK
Yellow	SCN-15-YELLOW	SCN-18-YELLOW	SCN-23-YELLOW	
Quantity / Package	300	300	50	50

PermaSleeve wire marking sleeves



PermaSleeve wire marking sleeves

Permanent heat shrink wire identification

Brady's non-adhesive, printable heat shrink wire marking sleeves fit snugly around wires or cables for maximum insulation protection and permanent identification. Brady's heat shrink sleeving is a full-circle design that provides fast and permanent wire marking. Clear, legible text can be printed on the wire and cable sleeving with a Brady printer for reliable wire identification.

Brady heat shrink sleeving materials excel in extreme environments, including temperature fluctuations and environments that require abrasion and chemical resistance. Brady offers a variety of materials available to print using thermal transfer and dot matrix printers.



PermaSleeve heat shrinkable wire marking sleeves comparison guide

Use the following table to help determine which PermaSleeve heat-shrinkable wire marking sleeves are right for your application. Then reference the following pages for more information and all available catalogue number.

Material	Product Category	Product Name Prefix	Available Colours*	Liner Platform	Shrink Ratio	Performance Attributes
B-342 PermaSleeve Polyolefin Wire Marking Sleeves	Industrial/ Military Grade	PS: Single-Sided 3PS: Double-Sided Example: 3PS-187-2-WT	Black, Blue, Brown, Green, Gray, Orange, Pink, Red, Violet, White, Yellow	Durable Paper Cardstock Liner	3:1	
B-345 PermaSleeve PVDF High Temperature Wire Marking Sleeves	High-Temperature	2HT: Double-Sided Example: 2HT-187-2-WT-S	Black, Blue, Pink, White, Yellow	Durable Paper Cardstock Liner	2:1 (3:1 for 3/32")	
B-7641 PermaSleeve Low Smoke Zero Halogen Polyolefin Wire Marking Sleeves	Low Smoke Zero Halogen	LSZH: Single-Sided 2LSZH: Double-Sided Example: 2ZH-187-2-WT	White, Yellow	Durable Paper Cardstock Liner	2:1	
B-7642 PermaSleeve Self-Extinguishing Polyolefin Wire Marking Sleeves	Industrial/ Military Grade	HX: Single-Sided 2HX: Double-Sided Example: 2HX-187-2-WT	Black, Blue, Brown, Green, Gray, Orange, Pink, Red, Violet, White, Yellow	Durable Paper Cardstock Liner	2:1	
B-7646 PermaSleeve Diesel Resistant Polyolefin Wire Marking Sleeves	Industrial/ Military Grade	3:1DPS: Double-Sided 3DPS: Double-Sided Example: 3DPS-4.8x50mm-B7646YL	Yellow	Durable Paper Cardstock Liner	3:1	-

*Some colours available only as special order

Printer compatibility

Printer compatibility for PermaSleeve Wire marking sleeves varies by catalogue number. Please see the following pages to find printer compatibility for each specific PermaSleeve wire marking sleeve material.



How to select a wire marker

There are four main questions to ask yourself when you're starting the process of marking wires. These questions will help you select a wire marker that best suits your needs.

1. Are you marking the wire after termination?

Sleeve markers can only be used before termination because they must be slipped over the open end of the wire. These non-adhesive markers provide flexibility as they can be moved prior to being heat-shrunk. Once shrunk, these markers fit snugly around wires for permanent identification which will stand up to harsh environments.

2. What size of wire are you marking?

The diameter of the wire determines the size of the sleeve or the height of the label to be used.

3. Will you print your own markers or purchase preprinted ones?

Pre-printed markers are available in a large variety of stock legends, and custom legends are available for any large jobs. These markers come in a variety of packaging and formats for ease of use and ease of transport. They are ideal for any application.

Printable markers are meant to be printed with variable legends as needed. Various methods for this include: portable wire marking printers or computer software linked to thermal transfer, dot matrix or laser-printers. An extensive array of sizes are available for every application. These printable markers offer the flexibility of printing legends on demand. They are also ideal for applications that require long legends.

4. In what type of environment will these wire markers be placed?

It is extremely important to select a wire marker material that will last for your application. Too many companies go to the trouble of marking only to have to do it all again because they did not select the correct material. Be sure to ask yourself these questions before you select your wire marker.

How to select a marker size

Brady offers a variety of marker sizes for your wire marking needs. Please view the chart listed below to assist you in choosing the minimum recommended flattened sleeve height for the wire or cable that you are identifying.

Sleeve code	Flattened Sleeve Height (mm)	Max. Wire/Cable Diameter (mm)	Min. Wire/Cable Diameter (mm)
B-342 PermaSleeve™ PS Polyolefin Wire Marking Sleeves			
094	4.62	2.03	0.58
125	5.97	2.79	1.17
187	8.51	3.81	1.57
250	11.15	5.46	2.39
375	16.38	8.13	3.18
500	21.62	11.43	4.75
750	31.75	17.78	6.35
1000	42.16	24.13	9.53
1500	61.80	36.83	12.70
B-345 PermaSleeve™ High Temperature PVDF Wire Marking Sleeves			
094	4.62	2.03	0.80
125	5.97	2.79	1.57
187	8.51	3.81	2.39
250	11.15	5.46	3.18
375	16.38	8.13	4.75
500	21.62	11.43	6.35
750	31.75	17.78	9.53
1000	42.16	24.13	11.40
1500	61.80	36.83	19.05
B-7641 PermaSleeve™ LSZH Low Smoke Zero Halogen Wire Marking Sleeves			
094	4.62	2.03	1.19
125	5.97	2.79	1.57
187	8.51	3.81	2.39
250	11.15	5.46	3.18
375	16.38	8.13	4.78
500	21.62	11.43	6.35
750	31.75	17.78	9.53
1000	42.16	24.13	12.70
1500	61.80	36.83	19.05
2000	80.39	49.53	25.40
B-7642 PermaSleeve™ Polyolefin Wire Marking Sleeves			
094	4.62	2.03	1.19
125	5.97	2.79	1.57
187	8.51	3.81	2.39
250	11.15	5.46	3.18
375	16.38	8.13	4.78
500	21.62	11.43	6.35
750	31.75	17.78	9.53
1000	42.16	24.13	12.70
1500	61.80	36.83	19.05
2000	80.39	49.53	25.40

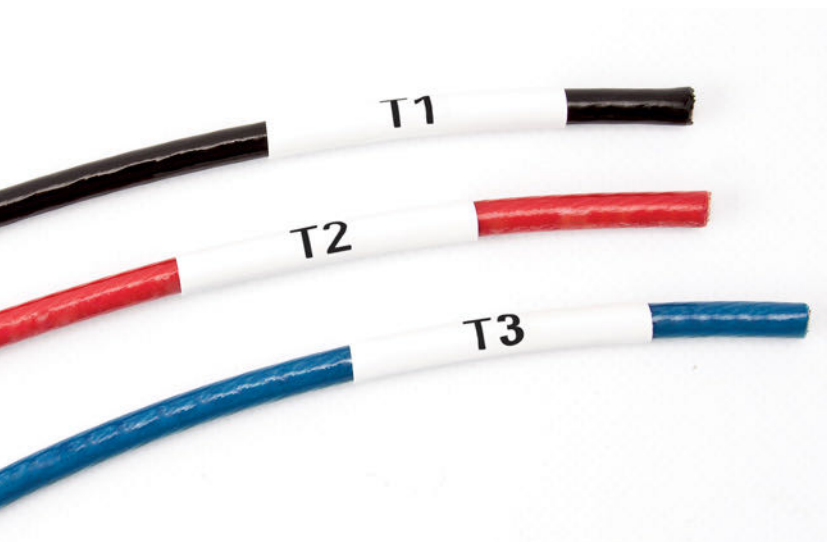

PermaSleeve wire marking sleeves

B-342 PermaSleeve polyolefin wire marking sleeves, 3:1 shrink ratio

B-342 PermaSleeve PS polyolefin wire marking sleeves are a 3:1 heat shrinkable wire marking sleeve that fits snugly around wires for identification and protection.

These fade-resistant and flame retardant sleeves have an operating temperature of -55°C to +130°C (-67°F to +275°F).

Performance attributes:



► How to read your PermaSleeve order reference

Example order reference:

3PS - 187 - 2 - WT - S - 4
 Product Diameter Width Colour Roll Size Pieces
 Optional

Order reference components of B-342 PermaSleeve PS wire marking sleeves:

Product Type
PS = Single Sided Printing, B-342
3PS = Double Sided Printing, B-342

Sleeve Diameter
094 = 3/32" size fits wire diameter 0.58mm - 2.03mm
125 = 1/8" size fits wire diameter 1.17mm - 2.79mm
187 = 3/16" size fits wire diameter 1.57mm - 3.81mm
250 = 1/4" size fits wire diameter 2.39mm - 5.46mm
375 = 3/8" size fits wire diameter 3.18mm - 8.13mm
500 = 1/2" size fits wire diameter 4.75mm - 11.43mm
750 = 3/4" size fits wire diameter 6.35mm - 17.78mm
1000 = 1" size fits wire diameter 9.53mm - 24.13mm
1500 = 1 1/2" size fits wire diameter 12.7mm - 36.83mm

Sleeve Width	
150 = 38.10mm	2 = 50.80mm

Sleeve Colour			
BK = Black	GR = Green	PK = Pink	WT = White
BL = Blue	GY = Gray	RD = Red	YL = Yellow
BR = Brown	OR = Orange	VT = Violet	

Optional: Roll Size	
If sleeve diameter is 094-250: Standard = 2,500 Small ("S") = 500	If sleeve diameter is 500: Standard = 500 Small ("S") = 250
If sleeve diameter is 375: Standard = 1,000 Small ("S") = 250	If sleeve diameter is 750-1500: Standard=250 Small ("S") = 100

Optional: Pieces Per Sleeve
While 1 marker per sleeve is standard, the sleeve can be split into multiple pieces. Example: PS-094-150-WT-2 This "2" means that this 38.10mm sleeve is slit into two 19.05mm pieces
Available options: 2, 3, or 4 pieces.

Recommended Ribbon Series: R4300, R6600, R6700 (with black sleeves) Series

Recommended Printer Series: BradyPrinter i7100 Industrial Label Printer, Brady IP Printer, BBP®72 Double Sided Printer

Software Compatibility: Brady Workstation, LabelMark Labelling Software, CodeSoft 9 Labelling Software

B-342 PermaSleeve polyolefin wire marking sleeves, 3:1 shrink ratio

Single-sided printable, 38.10 mm width

Use the table below to browse all available single-sided printing, 38.10 mm width B-342 PermaSleeve PS polyolefin wire marking sleeves.

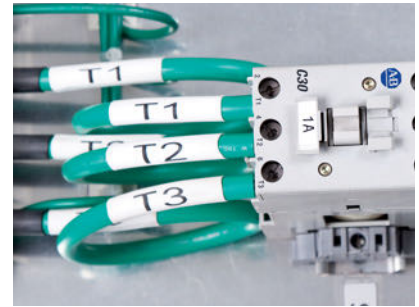

Order Reference	Colour	Wire Diameter Range (mm)	Label Height B (mm)	Label Width A (mm)	Vertical Repeat D (mm)	Labels per Row	Total Quantity per pack	Printer Compatibility	Printer Ribbon Series
B-342 : Heat-shrink Polyolefin									
PS-094-150-WT	White	0.58 to 2.03	4.62	38.10	12.70	1	2500	BBP12, BBP72, i7100	R6600
PS-094-150-WT-2	White	0.58 to 2.03	4.62	19.05	12.70	2	5000	BBP12, BBP72, i7100	R6600
PS-094-150-WT-4	White	0.58 to 2.03	4.62	9.53	12.70	4	10000	BBP12, BBP72, i7100	R6600
PS-094-150-WT-S	White	0.58 to 2.03	4.62	38.10	12.70	1	500	BBP12, BBP72, i7100	R6600
PS-094-150-WT-S-3	White	0.58 to 2.03	4.62	12.70	12.70	3	1500	BBP12, BBP72, i7100	R6600
PS-094-150-WT-S-4	White	0.58 to 2.03	4.62	9.53	12.70	4	2000	BBP12, BBP72, i7100	R6600
PS-125-150-WT	White	1.17 to 2.79	5.97	38.10	12.70	1	2500	BBP12, BBP72, i7100, i5100	R6600
PS-125-150-WT-2	White	1.17 to 2.79	5.97	19.05	12.70	2	5000	BBP12, BBP72, i7100, i5100	R6600
PS-125-150-WT-S	White	1.17 to 2.79	5.97	38.10	12.70	1	500	BBP12, BBP72, i7100, i5100	R6600
PS-125-150-WT-S-2	White	1.17 to 2.79	5.97	19.05	12.70	2	1000	BBP12, BBP72, i7100, i5100	R6600
PS-125-150-WT-S-3	White	1.17 to 2.79	5.97	12.70	12.70	3	1500	BBP12, BBP72, i7100, i5100	R6600
PS-187-150-WT	White	1.57 to 3.81	8.51	38.10	15.88	1	2500	BBP12, BBP72, i7100, i5100	R6600
PS-187-150-WT-2	White	1.57 to 3.81	8.51	19.05	15.88	2	5000	BBP12, BBP72, i7100, i5100	R6600
PS-187-150-WT-S	White	1.57 to 3.81	8.51	38.10	15.88	1	500	BBP12, BBP72, i7100, i5100	R6600
PS-187-150-WT-S-2	White	1.57 to 3.81	8.51	19.05	15.88	2	1000	BBP12, BBP72, i7100, i5100	R6600
PS-187-150-WT-S-4	White	1.57 to 3.81	8.51	9.53	15.88	4	2000	BBP12, BBP72, i7100, i5100	R6600
PS-250-150-WT	White	2.39 to 5.46	11.15	38.10	19.05	1	2500	BBP12, BBP72, i7100, i5100	R6600
PS-250-150-WT-2	White	2.39 to 5.46	11.15	19.05	19.05	2	5000	BBP12, BBP72, i7100, i5100	R6600
PS-250-150-WT-S	White	2.39 to 5.46	11.15	38.10	19.05	1	500	BBP12, BBP72, i7100, i5100	R6600
PS-250-150-WT-S-3	White	2.39 to 5.46	11.15	12.70	19.05	3	1500	BBP12, BBP72, i7100, i5100	R6600
PS-375-150-WT	White	3.18 to 8.13	16.38	38.10	25.40	1	1000	BBP12, BBP72, i7100, i5100	R6600
PS-375-150-WT-2	White	3.18 to 8.13	16.38	19.05	25.40	2	2000	BBP12, BBP72, i7100, i5100	R6600
PS-375-150-WT-S	White	3.18 to 8.13	16.38	38.10	25.40	1	250	BBP12, BBP72, i7100, i5100	R6600
PS-375-150-WT-S-2	White	3.18 to 8.13	16.38	19.05	25.40	2	1000	BBP12, BBP72, i7100, i5100	R6600
PS-375-150-WT-S-3	White	3.18 to 8.13	16.38	12.70	25.40	3	750	BBP12, BBP72, i7100, i5100	R6600
PS-500-150-WT	White	4.75 to 11.43	21.62	38.10	31.75	1	500	BBP12, BBP72, i7100, i5100	R6600
PS-500-150-WT-S	White	4.75 to 11.43	21.62	38.10	31.75	1	250	BBP12, BBP72, i7100, i5100	R6600
PS-500-150-WT-S-2	White	4.75 to 11.43	21.62	19.05	31.75	2	1000	BBP12, BBP72, i7100, i5100	R6600

Your PermaSleeve colour

While white is a standard colour, additional coloured sleeves are available as well. Simply replace "WT with the abbreviation of the desired colour to order.

Example: PS-094-150-**WT** becomes PS-094-150-**RD**

Available colours:

WT = White BR = Brown OR = Orange VT = Violet
 BK = Black GR = Green PK = Pink YL = Yellow
 BL = Blue GY = Gray RD = Red

Your PermaSleeve pieces (optional):

While 1 or 2 markers per sleeve is standard, you may also choose to have each sleeve slit multiple times to produce multiple pieces. Simply add the desired pieces per marker to the order reference.

Example: PS-187-150-WT-S becomes PS-187-150-WT-S-**4**
 This "4" means that this sleeve is slit into four pieces.

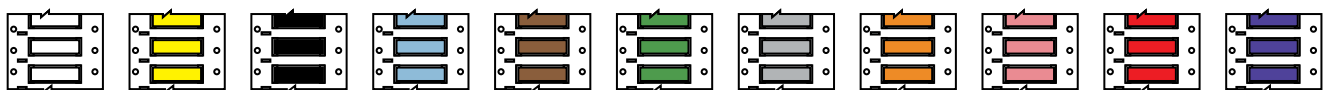

PermaSleeve wire marking sleeves



B-342 PermaSleeve polyolefin wire marking sleeves, 3:1 shrink ratio

Single-sided printable, 50.80 mm width

Use the table below to browse all available single-sided printing, 50.80 mm width B-342 PermaSleeve PS Polyolefin wire marking sleeves.

Order Reference	Colour	Wire Diameter Range (mm)	Label Height B (mm)	Label Width A (mm)	Vertical Repeat D (mm)	Labels per Row	Total Quantity per pack	Printer Compatibility	Printer Ribbon Series
B-342 : Heat-shrink Polyolefin									
PS-094-2-WT	White	0.58 to 2.03	4.62	50.80	12.70	1	2500	BBP12, BBP72, i7100	R6600
PS-094-2-WT-2	White	0.58 to 2.03	4.62	25.40	12.70	2	5000	BBP12, BBP72, i7100	R6600
PS-094-2-WT-S	White	0.58 to 2.03	4.62	50.80	12.70	1	500	BBP12, BBP72, i7100	R6600
PS-094-2-WT-S-2	White	0.58 to 2.03	4.62	25.40	12.70	2	1000	BBP12, BBP72, i7100	R6600
PS-094-2-WT-S-4	White	0.58 to 2.03	4.62	12.70	12.70	4	2000	BBP12, BBP72, i7100	R6600
PS-125-2-WT	White	1.17 to 2.79	5.97	50.80	12.70	1	2500	BBP12, BBP72, i7100, i5100	R6600
PS-125-2-WT-2	White	1.17 to 2.79	5.97	25.40	12.70	2	5000	BBP12, BBP72, i7100, i5100	R6600
PS-125-2-WT-S	White	1.17 to 2.79	5.97	50.80	12.70	1	500	BBP12, BBP72, i7100, i5100	R6600
PS-125-2-WT-S-2	White	1.17 to 2.79	5.97	25.40	12.70	2	1000	BBP12, BBP72, i7100, i5100	R6600
PS-125-2-WT-S-4	White	1.17 to 2.79	5.97	12.70	12.70	4	2000	BBP12, BBP72, i7100, i5100	R6600
PS-187-2-WT	White	1.57 to 3.81	8.51	50.80	15.88	1	2500	BBP12, BBP72, i7100, i5100	R6600
PS-187-2-WT-2	White	1.57 to 3.81	8.51	25.40	15.88	2	5000	BBP12, BBP72, i7100, i5100	R6600
PS-187-2-WT-3	White	1.57 to 3.81	8.51	17.02	15.88	3	7500	BBP12, BBP72, i7100, i5100	R6600
PS-187-2-WT-4	White	1.57 to 3.81	8.51	12.70	15.88	4	10000	BBP12, BBP72, i7100, i5100	R6600
PS-187-2-WT-S	White	1.57 to 3.81	8.51	50.80	15.88	1	500	BBP12, BBP72, i7100, i5100	R6600
PS-187-2-WT-S-2	White	1.57 to 3.81	8.51	25.40	15.88	2	1000	BBP12, BBP72, i7100, i5100	R6600
PS-187-2-WT-S-3	White	1.57 to 3.81	8.51	17.02	15.88	3	1500	BBP12, BBP72, i7100, i5100	R6600
PS-187-2-WT-S-4	White	1.57 to 3.81	8.51	12.70	15.88	4	2000	BBP12, BBP72, i7100, i5100	R6600
PS-250-2-WT	White	2.39 to 5.46	11.15	50.80	19.05	1	2500	BBP12, BBP72, i7100, i5100	R6600
PS-250-2-WT-2	White	2.39 to 5.46	11.15	25.40	19.05	2	5000	BBP12, BBP72, i7100, i5100	R6600
PS-250-2-WT-S	White	2.39 to 5.46	11.15	50.80	19.05	1	500	BBP12, BBP72, i7100, i5100	R6600
PS-250-2-WT-S-2	White	2.39 to 5.46	11.15	25.40	19.05	2	1000	BBP12, BBP72, i7100, i5100	R6600
PS-250-2-WT-S-3	White	2.39 to 5.46	11.15	17.02	19.05	3	1500	BBP12, BBP72, i7100, i5100	R6600
PS-250-2-WT-S-4	White	2.39 to 5.46	11.15	12.70	19.05	4	2000	BBP12, BBP72, i7100, i5100	R6600
PS-375-2-WT	White	3.18 to 8.13	16.38	50.80	25.40	1	1000	BBP12, BBP72, i7100, i5100	R6600
PS-375-2-WT-2	White	3.18 to 8.13	16.38	25.40	25.40	2	2000	BBP12, BBP72, i7100, i5100	R6600
PS-375-2-WT-4	White	3.18 to 8.13	16.38	12.70	25.40	4	4000	BBP12, BBP72, i7100, i5100	R6600
PS-375-2-WT-S	White	3.18 to 8.13	16.38	50.80	25.40	1	250	BBP12, BBP72, i7100, i5100	R6600
PS-375-2-WT-S-2	White	3.18 to 8.13	16.38	25.40	25.40	2	1000	BBP12, BBP72, i7100, i5100	R6600
PS-500-2-WT	White	4.75 to 11.43	21.62	50.80	31.75	1	500	BBP12, BBP72, i7100, i5100	R6600
PS-500-2-WT,BULK (2500 PCS/ROLL)	White	4.75 to 11.43	21.62	50.80	31.75	1	2500	BBP12, BBP72, i7100, i5100	R6600
PS-500-2-WT-2	White	4.75 to 11.43	21.62	25.40	31.75	2	1000	BBP12, BBP72, i7100, i5100	R6600
PS-500-2-WT-S	White	4.75 to 11.43	21.62	50.80	31.75	1	250	BBP12, BBP72, i7100, i5100	R6600
PS-500-2-WT-S-2	White	4.75 to 11.43	21.62	25.40	31.75	2	500	BBP12, BBP72, i7100, i5100	R6600
PS-750-2-WT	White	6.35 to 17.78	31.75	50.80	41.28	1	250	BBP12, BBP72, i7100, i5100	R6600
PS-750-2-WT-S	White	6.35 to 17.78	31.75	50.80	41.28	1	100	BBP12, BBP72, i7100, i5100	R6600
PS-1000-2-WT-2	White	8.46 to 24.13	42.16	25.40	50.80	2	500	BBP12, BBP72, i7100, i5100	R6600
PS-1000-2-WT	White	9.53 to 24.13	42.16	50.80	50.80	1	250	BBP12, BBP72, i7100, i5100	R6600
PS-1500-2-WT	White	12.70 to 36.83	61.80	50.80	76.20	1	250	BBP12, BBP72, i7100, i5100	R6600

Your PermaSleeve colour

While white is a standard colour, additional coloured sleeves are available as well. Simply replace "WT with the abbreviation of the desired colour to order.

Example: PS-094-150-**WT** becomes PS-094-150-**RD**

Available colours:

WT = White BR = Brown OR = Orange VT = Violet
 BK = Black GR = Green PK = Pink YL = Yellow
 BL = Blue GY = Gray RD = Red

Your PermaSleeve pieces (optional):

While 1 or 2 markers per sleeve is standard, you may also choose to have each sleeve slit multiple times to produce multiple pieces. Simply add the desired pieces per marker to the order reference.

Example: PS-187-150-WT-S becomes PS-187-150-WT-S-**4**
 This "4 means that this sleeve is slit into four pieces.

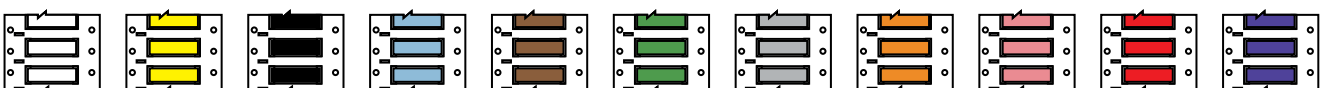

B-342 PermaSleeve polyolefin wire marking sleeves, 3:1 shrink ratio

Double-sided printable, 50.80 mm width

Use the table below to browse all available double-sided printing, 50.80 mm width B-342 PermaSleeve 3PS polyolefin wire marking sleeves.



Order Reference	Colour	Wire Diameter Range (mm)	Label Height B (mm)	Label Width A (mm)	Vertical Repeat D (mm)	Labels per Row	Total Quantity per pack	Printer Compatibility	Printer Ribbon Series
B-342 : Heat-shrink Polyolefin									
3PS-094-2-WT	White	0.58 to 2.03	4.62	50.80	12.70	1	2500	BBP72	R6600
3PS-094-2-WT-2	White	0.58 to 2.03	4.62	25.40	12.70	2	5000	BBP72	R6600
3PS-094-2-WT-4	White	0.58 to 2.03	4.62	12.70	12.70	4	10000	BBP72	R6600
3PS-094-2-WT-S	White	0.58 to 2.03	4.62	50.80	12.70	1	500	BBP72	R6600
3PS-094-2-WT-S-2	White	0.58 to 2.03	4.62	25.40	12.70	2	1000	BBP72	R6600
3PS-125-2-WT	White	1.17 to 2.79	5.97	50.80	12.70	1	2500	BBP72	R6600
3PS-125-2-WT-2	White	1.17 to 2.79	5.97	25.40	12.70	2	5000	BBP72	R6600
3PS-125-2-WT-3	White	1.17 to 2.79	5.97	17.02	12.70	3	7500	BBP72	R6600
3PS-125-2-WT-4	White	1.17 to 2.79	5.97	12.70	12.70	4	10000	BBP72	R6600
3PS-125-2-WT-S	White	1.17 to 2.79	5.97	50.80	12.70	1	500	BBP72	R6600
3PS-125-2-WT-S-2	White	1.17 to 2.79	5.97	25.40	12.70	2	1000	BBP72	R6600
3PS-187-2-WT	White	1.57 to 3.81	8.51	50.80	15.88	1	2500	BBP72	R6600
3PS-187-2-WT-2	White	1.57 to 3.81	8.51	25.40	15.88	2	5000	BBP72	R6600
3PS-187-2-WT-3	White	1.57 to 3.81	8.51	17.02	15.88	3	7500	BBP72	R6600
3PS-187-2-WT-4	White	1.57 to 3.81	8.51	12.70	15.88	4	10000	BBP72	R6600
3PS-187-2-WT-S	White	1.57 to 3.81	8.51	50.80	15.88	1	500	BBP72	R6600
3PS-187-2-WT-S-2	White	1.57 to 3.81	8.51	25.40	15.88	2	1000	BBP72	R6600
3PS-187-2-WT-S-4	White	1.57 to 3.81	8.51	12.70	15.88	4	2000	BBP72	R6600
3PS-250-2-WT	White	2.39 to 5.46	11.15	50.80	19.05	1	2500	BBP72	R6600
3PS-250-2-WT-2	White	2.39 to 5.46	11.15	25.40	19.05	2	5000	BBP72	R6600
3PS-250-2-WT-3	White	2.39 to 5.46	11.15	17.02	19.05	3	7500	BBP72	R6600
3PS-250-2-WT-S	White	2.39 to 5.46	11.15	50.80	19.05	1	500	BBP72	R6600
3PS-250-2-WT-S-2	White	2.39 to 5.46	11.15	25.40	19.05	2	1000	BBP72	R6600
3PS-375-2-WT	White	3.18 to 8.13	16.38	50.80	25.40	1	1000	BBP72	R6600
3PS-375-2-WT-2	White	3.18 to 8.13	16.38	25.40	25.40	2	2000	BBP72	R6600
3PS-375-2-WT-S	White	3.18 to 8.13	16.38	50.80	25.40	1	250	BBP72	R6600
3PS-375-2-WT-S-2	White	3.18 to 8.13	16.38	25.40	25.40	2	500	BBP72	R6600
3PS-500-2-WT	White	4.75 to 11.43	21.62	50.80	31.75	1	500	BBP72	R6600
3PS-500-2-WT-2	White	4.75 to 11.43	21.62	25.40	31.75	2	1000	BBP72	R6600
3PS-500-2-WT-S	White	4.75 to 11.43	21.62	50.80	31.75	1	250	BBP72	R6600
3PS-750-2-WT	White	6.35 to 17.78	31.75	50.80	41.28	1	250	BBP72	R6600
3PS-750-2-WT-S	White	6.35 to 17.78	31.75	50.80	41.28	1	100	BBP72	R6600
3PS-1000-2-WT	White	8.46 to 24.13	42.16	50.80	50.80	1	250	BBP72	R6600
3PS-1500-2-WT	White	12.70 to 36.83	61.80	50.80	76.20	1	250	BBP72	R6600

Your PermaSleeve colour

While white is a standard colour, additional coloured sleeves are available as well. Simply replace "WT with the abbreviation of the desired colour to order.

Example: PS-094-150-**WT** becomes PS-094-150-**RD**

Available colours:

WT = White BR = Brown OR = Orange VT = Violet
 BK = Black GR = Green PK = Pink YL = Yellow
 BL = Blue GY = Gray RD = Red

Your PermaSleeve pieces (optional):

While 1 or 2 markers per sleeve is standard, you may also choose to have each sleeve slit multiple times to produce multiple pieces. Simply add the desired pieces per marker to the order reference.

Example: PS-187-150-WT-S becomes PS-187-150-WT-S-**4**
 This "4 means that this sleeve is slit into four pieces.

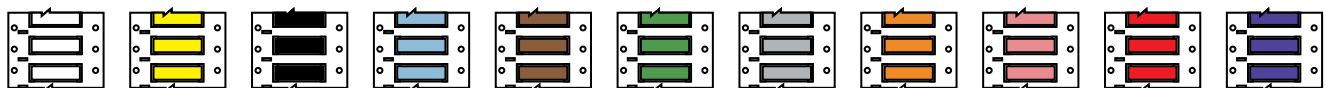

B-345 PermaSleeve PVDF high temperature wire marking sleeves, 2:1 shrink ratio

B-345 PermaSleeve HT high temperature PVDF wire marking sleeves are a 2:1 (3/32 is 3:1) heat shrinkable wire marking sleeve specifically designed for high temperature and low vacuum outgassing applications. These heat shrinkable wire marking sleeves are made from irradiated high temperature PVDF and have an operating temperature of -55°C to +225°C (-67°F to +437°F).

Performance attributes:



► How to read your PermaSleeve order reference

Example order reference:

2HT - 187 - 2 - WT - S
 Product Diameter Width Colour Roll Size

Available options for B-345 PermaSleeve® HT Wire Marking Sleeves:

Product Type
Offered in Double Sided Product Format
3HT = 3:1 Shrink Ratio, 3/32" only, B-345
2HT = 2:1 Shrink Ratio, 1/8" through 1 1/2", B-345

Sleeve Diameter
094 = 3/32" size fits wire diameter 0.6 mm - 2.0 mm
125 = 1/8" size fits wire diameter 1.2 mm - 2.8 mm
187 = 3/16" size fits wire diameter 1.6 mm - 3.8 mm
250 = 1/4" size fits wire diameter 2.4 mm - 5.5 mm
375 = 3/8" size fits wire diameter 3.2 mm - 8.1 mm
500 = 1/2" size fits wire diameter 4.8 mm - 11.4 mm
750 = 3/4" size fits wire diameter 6.6 mm - 17.8 mm
1000 = 1" size fits wire diameter 11.4 mm - 24.1 mm
1500 = 1 1/2" size fits wire diameter 12.7 mm - 36.8 mm

Sleeve Width
2 = 50.80mm

Sleeve Colour
WT = White BL = Blue YL = Yellow BK = Black PK = Pink

Roll Size	
Note: Small size is standard.	
If sleeve diameter is 094–250: Standard Small Size ("S") = 500	If sleeve diameter is 750–1500: Standard Small Size ("S") = 100
If sleeve diameter is 375–500 Standard Small Size ("S") = 250	

Recommended Ribbon Series: R6000, R6600, and R4400 (with black sleeves) Series

Recommended Printer Series: BradyPrinter i7100 Industrial Label Printer, Brady IP Printer, BBP®72 Double Sided Printer

Software Compatibility: Brady Workstation, LabelMark Labelling Software, CodeSoft 9 Labelling Software

B-345 PermaSleeve PVDF high temperature wire marking sleeves, 2:1 shrink ratio

Double-sided printable, 50.80 mm width

Use the table below to browse all available double-sided printing, 50.80 mm width B-345 PermaSleeve HT High Temperature PVDF wire marking sleeves.



Order Reference	Colour	Wire Diameter Range (mm)	Label Height B (mm)	Label Width A (mm)	Vertical Repeat D (mm)	Labels per Row	Total Quantity per pack	Printer Compatibility	Printer Ribbon Series
B-345 : High Temperature Heat-shrink Polyvinylidene Fluoride Sleeve									
3HT-094-2-WT-S	White	0.80 to 2.03	4.62	50.80	12.70	1	500	BBP72	R6600
2HT-125-2-WT-S	White	1.57 to 2.79	5.97	50.80	12.70	1	500	BBP72	R6600
2HT-187-2-WT-S	White	2.39 to 3.81	8.51	50.80	15.88	1	500	BBP72	R6600
2HT-250-2-WT-S	White	3.18 to 5.46	11.15	50.80	19.05	1	500	BBP72	R6600
2HT-375-2-WT-S	White	4.75 to 8.13	16.38	50.80	25.40	1	250	BBP72	R6600
2HT-500-2-WT-S	White	6.35 to 11.43	21.62	50.80	31.75	1	250	BBP72	R6600
2HT-750-2-WT-S	White	9.53 to 17.78	31.75	50.80	41.28	1	100	BBP72	R6600
2HT-1000-2-WT-S	White	11.40 to 24.13	42.16	50.80	50.80	1	100	BBP72	R6600
2HT-1500-2-WT-S	White	19.05 to 36.83	61.80	50.80	76.20	1	100	BBP72	R6600

Choosing your PermaSleeve colour

While white is a standard colour, additional coloured sleeves are available as well. Simply replace "WT with the abbreviation of the desired colour to order.

Example: 2HT-094-2-**WT**-S becomes 2HT-094-2-**YL**-S

Available colours:

- WT = White
- BK = Black
- BL = Blue
- PK = Pink
- YL = Yellow

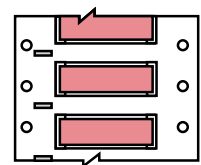
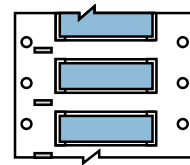
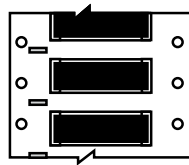
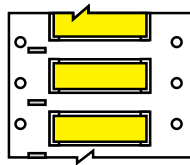
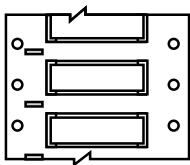

B-7641 PermaSleeve LSZH low smoke zero halogen polyolefin wire marking sleeves, 2:1 shrink ratio

B-7641 Permasleeve LSZH low smoke zero halogen polyolefin wire marking sleeves are 2:1 heat shrinkable, halogen free wire marking sleeves. The wire marking sleeves offer outstanding fire safety properties and minimal smoke emission.

Performance attributes:



► How to read your PermaSleeve order reference

Example order reference:

2LSZH - 187 - 2 - WT - S - 4

Product	Diameter	Width	Colour	Roll Size	Pieces
				Optional	

Available options for B-7641 PermaSleeve LSZH Wire Marking Sleeves:

Product Type
LSZH = Single Sided Printing, B-7641
2LSZH = Double Sided Printing, B-7641

Sleeve Diameter
094 = 3/32" size fits wire diameter 1.19 mm - 2.03 mm
125 = 1/8" size fits wire diameter 1.57 mm - 2.79 mm
187 = 3/16" size fits wire diameter 2.39 mm - 3.83 mm
250 = 1/4" size fits wire diameter 3.17 mm - 5.46 mm
375 = 3/8" size fits wire diameter 4.77 mm - 8.13 mm
500 = 1/2" size fits wire diameter 6.35 mm - 11.43 mm
750 = 3/4" size fits wire diameter 9.52 mm - 17.78 mm
1000 = 1" size fits wire dia. 11.43 mm - 24.13 mm
1500 = 1 1/2" size fits wire diameter 19.05 mm - 35.56 mm
2000 = 2" size fits wire diameter 25.40 mm - 48.26 mm

Sleeve Width	
150 = 38.10 mm	2 = 50.80 mm

Sleeve Colour
Standard Colours
WT = White YL = Yellow

Optional: Roll Size	
If sleeve diameter is 094-187: Standard = 2,500 Small ("S") = 500	If sleeve diameter is 750-1500: Standard = 250 Small ("S") = 100
If sleeve diameter is 250-375: Standard = 1,000 Small ("S") = 250	If sleeve diameter is 2000: Standard = 100 Small ("S") = 50
If sleeve diameter is 500: Standard = 500 Small ("S") = 250	

Optional: Pieces Per Sleeve
While 1 marker per sleeve is standard, the sleeve can be split into multiple pieces. Insert number of pieces into "Pieces" blank. Example: 2LSZH-187-2-WT-4 This "4" means this sleeve is slit into four pieces
Available options: 2, 3, or 4 pieces.

Recommended Ribbon Series: R4300, R6400, R6600

Recommended Printer Series: BradyPrinter i7100 Industrial Label Printer, BBP72 Double Sided Printer

Software Compatibility: Brady Workstation, LabelMark Labelling Software, CodeSoft 9 Labelling Software

B-7641 PermaSleeve LSZH low smoke zero halogen polyolefin wire marking sleeves, 2:1 shrink ratio

Single-sided printable, 50.80 mm width

Use the table below to browse all available single-sided printing, 50.80 mm width B-7641 Permasleeve LSZH low smoke zero halogen polyolefin wire marking sleeves.

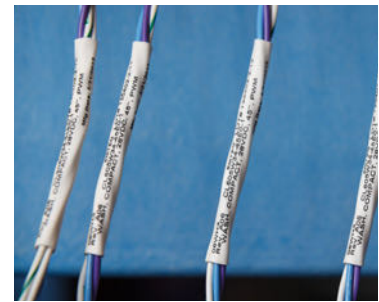

Order Reference	Colour	Wire Diameter Range (mm)	Label Height B (mm)	Label Width A (mm)	Vertical Repeat D (mm)	Labels per Row	Total Quantity per pack	Printer Compatibility	Printer Ribbon Series
B-7641 : Heat-shrink Polyolefin									
LSZH-094-2-WT	White	1.19 to 2.03	4.62	50.80	12.70	1	2500	BBP12, BBP72, i7100	R6600
LSZH-094-2-WT-2	White	1.19 to 2.03	4.62	25.40	12.70	2	5000	BBP12, BBP72, i7100	R6600
LSZH-094-2-WT-4	White	1.19 to 2.03	4.62	12.70	12.70	4	10000	BBP12, BBP72, i7100	R6600
LSZH-094-2-WT-S	White	1.19 to 2.03	4.62	50.80	12.70	1	500	BBP12, BBP72, i7100	R6600
LSZH-125-150-YL-2	Yellow	1.57 to 2.79	5.97	19.05	12.70	2	5000	BBP12, BBP72, i7100	R6600
LSZH-125-2-WT	White	1.57 to 2.79	5.97	50.80	12.70	1	2500	BBP12, BBP72, i7100	R6600
LSZH-125-2-WT-2	White	1.57 to 2.79	5.97	25.40	12.70	2	5000	BBP12, BBP72, i7100	R6600
LSZH-125-2-WT-4	White	1.57 to 2.79	5.97	12.70	12.70	4	10000	BBP12, BBP72, i7100	R6600
LSZH-125-2-WT-S	White	1.57 to 2.79	5.97	50.80	12.70	1	500	BBP12, BBP72, i7100	R6600
LSZH-187-2-WT	White	2.39 to 3.81	8.51	50.80	15.88	1	2500	BBP12, BBP72, i7100	R6600
LSZH-187-2-WT-2	White	2.39 to 3.81	8.51	25.40	15.88	2	5000	BBP12, BBP72, i7100	R6600
LSZH-187-2-WT-4	White	2.39 to 3.81	8.51	12.70	15.88	4	10000	BBP12, BBP72, i7100	R6600
LSZH-187-2-WT-S	White	2.39 to 3.81	8.51	50.80	15.88	1	500	BBP12, BBP72, i7100	R6600
LSZH-250-2-WT	White	3.18 to 5.46	11.15	50.80	19.05	1	2500	BBP12, BBP72, i7100	R6600
LSZH-250-2-WT-2	White	3.18 to 5.46	11.15	25.40	19.05	2	5000	BBP12, BBP72, i7100	R6600
LSZH-250-2-WT-4	White	3.18 to 5.46	11.15	12.70	19.05	4	10000	BBP12, BBP72, i7100	R6600
LSZH-250-2-WT-S	White	3.18 to 5.46	11.15	50.80	19.05	1	500	BBP12, BBP72, i7100	R6600
LSZH-375-2-WT	White	4.78 to 8.13	16.38	50.80	25.40	1	1000	BBP12, BBP72, i7100	R6600
LSZH-375-2-WT-2	White	4.78 to 8.13	16.38	25.40	25.40	2	2000	BBP12, BBP72, i7100	R6600
LSZH-375-2-WT-S	White	4.78 to 8.13	16.38	50.80	25.40	1	250	BBP12, BBP72, i7100	R6600
LSZH-500-2-WT	White	6.35 to 11.43	21.62	50.80	31.75	1	500	BBP12, BBP72, i7100	R6600
LSZH-500-2-WT-2	White	6.35 to 11.43	21.62	25.40	31.75	2	1000	BBP12, BBP72, i7100	R6600
LSZH-500-2-WT-S	White	6.35 to 11.43	21.62	50.80	31.75	1	250	BBP12, BBP72, i7100	R6600
LSZH-750-2-WT	White	9.53 to 17.78	31.75	50.80	41.28	1	250	BBP12, BBP72, i7100	R6600
LSZH-750-2-WT-2	White	9.53 to 17.78	31.75	25.40	41.28	2	500	BBP12, BBP72, i7100	R6600
LSZH-1000-2-WT	White	12.70 to 24.13	42.16	50.80	50.80	1	250	BBP12, BBP72, i7100	R6600
LSZH-1000-2-WT-2	White	12.70 to 24.13	42.16	25.40	50.80	2	500	BBP12, BBP72, i7100	R6600
LSZH-1000-2-WT-4	White	12.70 to 24.13	42.16	12.70	50.80	4	1000	BBP12, BBP72, i7100	R6600
LSZH-1500-2-WT	White	19.05 to 36.83	61.80	50.80	76.20	1	250	BBP12, BBP72, i7100	R6600
LSZH-2000-2-WT	White	25.40 to 48.26	80.39	50.80	101.60	1	100	BBP12, BBP72, i7100	R6600
LSZH-2000-2-WT-S	White	25.40 to 48.26	80.39	50.80	101.60	1	50	BBP12, BBP72, i7100	R6600
LSZH-2000-3-WT	White	25.40 to 48.26	80.39	76.20	101.60	1	100	BBP12, BBP72, i7100	R6600

Choosing your PermaSleeve colour

While white and yellow are standard colours, additional coloured sleeves are available as well. Simply replace "WT" with the abbreviation of the desired colour to order.

Example: ZH-094-2-**WT**-S becomes ZH-094-2-**RD**-S

Standard colours:

WT = White
YL = Yellow

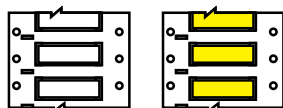

Choosing your PermaSleeve pieces (optional)

While 1 or 2 markers per sleeve is standard, you may also choose to have each sleeve slit multiple times to produce multiple pieces. Simply add the desired pieces per marker to the order reference.

Example: LSZH-187-2-WT becomes LSZH-187-2-WT-**4**
This "4" means that this sleeve is slit into four pieces.

Standard options:

1 or 2 markers per sleeve

Other available slit options:

3 or 4 markers per sleeve
(Contact Brady customer service for availability)

PermaSleeve wire marking sleeves



B-7641 PermaSleeve LSZH low smoke zero halogen polyolefin wire marking sleeves, 2:1 shrink ratio

Single-sided printable, 50.80 mm width

Use the table below to browse all available single-sided printing, 50.80 mm width B-7641 Permasleeve LSZH low smoke zero halogen polyolefin wire marking sleeves.

Order Reference	Colour	Wire Diameter Range (mm)	Label Height B (mm)	Label Width A (mm)	Vertical Repeat D (mm)	Labels per Row	Total Quantity per pack	Printer Compatibility	Printer Ribbon Series
B-7641 : Heat-shrink Polyolefin									
LSZH-094-2-WT	White	1.19 to 2.03	4.62	50.80	12.70	1	2500	BBP12, BBP72, i7100	R6600
LSZH-094-2-WT-2	White	1.19 to 2.03	4.62	25.40	12.70	2	5000	BBP12, BBP72, i7100	R6600
LSZH-094-2-WT-4	White	1.19 to 2.03	4.62	12.70	12.70	4	10000	BBP12, BBP72, i7100	R6600
LSZH-094-2-WT-S	White	1.19 to 2.03	4.62	50.80	12.70	1	500	BBP12, BBP72, i7100	R6600
LSZH-125-150-YL-2	Yellow	1.57 to 2.79	5.97	19.05	12.70	2	5000	BBP12, BBP72, i7100	R6600
LSZH-125-2-WT	White	1.57 to 2.79	5.97	50.80	12.70	1	2500	BBP12, BBP72, i7100	R6600
LSZH-125-2-WT-2	White	1.57 to 2.79	5.97	25.40	12.70	2	5000	BBP12, BBP72, i7100	R6600
LSZH-125-2-WT-4	White	1.57 to 2.79	5.97	12.70	12.70	4	10000	BBP12, BBP72, i7100	R6600
LSZH-125-2-WT-S	White	1.57 to 2.79	5.97	50.80	12.70	1	500	BBP12, BBP72, i7100	R6600
LSZH-187-2-WT	White	2.39 to 3.81	8.51	50.80	15.88	1	2500	BBP12, BBP72, i7100	R6600
LSZH-187-2-WT-2	White	2.39 to 3.81	8.51	25.40	15.88	2	5000	BBP12, BBP72, i7100	R6600
LSZH-187-2-WT-4	White	2.39 to 3.81	8.51	12.70	15.88	4	10000	BBP12, BBP72, i7100	R6600
LSZH-187-2-WT-S	White	2.39 to 3.81	8.51	50.80	15.88	1	500	BBP12, BBP72, i7100	R6600
LSZH-250-2-WT	White	3.18 to 5.46	11.15	50.80	19.05	1	2500	BBP12, BBP72, i7100	R6600
LSZH-250-2-WT-2	White	3.18 to 5.46	11.15	25.40	19.05	2	5000	BBP12, BBP72, i7100	R6600
LSZH-250-2-WT-4	White	3.18 to 5.46	11.15	12.70	19.05	4	10000	BBP12, BBP72, i7100	R6600
LSZH-250-2-WT-S	White	3.18 to 5.46	11.15	50.80	19.05	1	500	BBP12, BBP72, i7100	R6600
LSZH-375-2-WT	White	4.78 to 8.13	16.38	50.80	25.40	1	1000	BBP12, BBP72, i7100	R6600
LSZH-375-2-WT-2	White	4.78 to 8.13	16.38	25.40	25.40	2	2000	BBP12, BBP72, i7100	R6600
LSZH-375-2-WT-S	White	4.78 to 8.13	16.38	50.80	25.40	1	250	BBP12, BBP72, i7100	R6600
LSZH-500-2-WT	White	6.35 to 11.43	21.62	50.80	31.75	1	500	BBP12, BBP72, i7100	R6600
LSZH-500-2-WT-2	White	6.35 to 11.43	21.62	25.40	31.75	2	1000	BBP12, BBP72, i7100	R6600
LSZH-500-2-WT-S	White	6.35 to 11.43	21.62	50.80	31.75	1	250	BBP12, BBP72, i7100	R6600
LSZH-750-2-WT	White	9.53 to 17.78	31.75	50.80	41.28	1	250	BBP12, BBP72, i7100	R6600
LSZH-750-2-WT-2	White	9.53 to 17.78	31.75	25.40	41.28	2	500	BBP12, BBP72, i7100	R6600
LSZH-1000-2-WT	White	12.70 to 24.13	42.16	50.80	50.80	1	250	BBP12, BBP72, i7100	R6600
LSZH-1000-2-WT-2	White	12.70 to 24.13	42.16	25.40	50.80	2	500	BBP12, BBP72, i7100	R6600
LSZH-1000-2-WT-4	White	12.70 to 24.13	42.16	12.70	50.80	4	1000	BBP12, BBP72, i7100	R6600
LSZH-1500-2-WT	White	19.05 to 36.83	61.80	50.80	76.20	1	250	BBP12, BBP72, i7100	R6600
LSZH-2000-2-WT	White	25.40 to 48.26	80.39	50.80	101.60	1	100	BBP12, BBP72, i7100	R6600
LSZH-2000-2-WT-S	White	25.40 to 48.26	80.39	50.80	101.60	1	50	BBP12, BBP72, i7100	R6600
LSZH-2000-3-WT	White	25.40 to 48.26	80.39	76.20	101.60	1	100	BBP12, BBP72, i7100	R6600

Choosing your PermaSleeve colour

While white and yellow are standard colours, additional coloured sleeves are available as well. Simply replace "WT" with the abbreviation of the desired colour to order.

Example: ZH-094-2-**WT**-S becomes ZH-094-2-**RD**-S

Standard colours:

WT = White

YL = Yellow

Choosing your PermaSleeve pieces (optional)

While 1 or 2 markers per sleeve is standard, you may also choose to have each sleeve slit multiple times to produce multiple pieces. Simply add the desired pieces per marker to the order reference.

Example: LSZH-187-2-WT becomes LSZH-187-2-WT-**4**

This "4" means that this sleeve is slit into four pieces.

Standard options:

1 or 2 markers per sleeve

Other available slit options:

3 or 4 markers per sleeve
(Contact Brady customer service for availability)

B-7642 PermaSleeve HX self-extinguishing polyolefin wire marking sleeves, 2:1 shrink ratio

B-7642 PermaSleeve HX polyolefin wire marking Sleeves are 2:1 heat shrinkable wire marking sleeves. The sleeves are high-temperature rated, highly flame retardant, and very flexible. These heat shrinkable wire marking sleeves have an operating temperature of -40°C to 120°C (-40°F to 248°F).

Performance attributes:



▶ How to read your PermaSleeve order reference

Example order reference:

2HX - 187 - 2 - WT - S - 4

Product	Diameter	Width	Colour	Roll Size	Pieces
2HX	187	2	WT	S	4
				Optional*	

Available options for B-7642 PermaSleeve HX Wire Marking Sleeve:

Product Type
HX = Single Sided Printing, B-7642
2HX = Double Sided Printing, B-7642

Sleeve Diameter
094 = 3/32" size fits wire diameter 1.19 mm - 2.03 mm
125 = 1/8" size fits wire diameter 1.57 mm - 2.79 mm
187 = 3/16" size fits wire diameter 2.39 mm - 3.83 mm
250 = 1/4" size fits wire diameter 3.17 mm - 5.46 mm
375 = 3/8" size fits wire diameter 4.77 mm - 8.13 mm
500 = 1/2" size fits wire diameter 6.35 mm - 11.43 mm
750 = 3/4" size fits wire diameter 9.52 mm - 17.78 mm
1000 = 1" size fits wire diameter 11.43 mm - 24.13 mm
1500 = 1 1/2" size fits wire diameter 19.05 mm - 35.56 mm
2000 = 2" size fits wire diameter 25.40 mm - 48.26 mm

Sleeve Width
150 = 38.10 mm 2 = 2" 3 = 76.20 mm (only available in 1000, 1500, & 2000 diameter parts)

Sleeve Colour
Colours for HX and 2HX
WT = White BL = Blue GY = Gray PK = Pink VT = Violet
BK = Black GR = Green OR = Orange RD = Red YL = Yellow

Optional: Roll Size		
If sleeve diameter is 094–187: Standard = 2,500 Small ("S") = 500 Jumbo ("J") = 10,000	If sleeve diameter is 500: Standard = 500 Small ("S") = 250 Jumbo ("J") = 2,500	If sleeve diameter is 1500: Standard = 250 Small ("S") = 100 Jumbo ("J") = 1,000
If sleeve diameter is 250: Standard = 1,000 Small ("S") = 250 Jumbo ("J") = 7,500	If sleeve diameter is 750–1000: Standard = 250 Small ("S") = 100 Jumbo ("J") = 2,500	If sleeve diameter is 2000: Standard = 100 Small ("S") = 50 Jumbo ("J") = 1,000
If sleeve diameter is 375: Standard = 1,000 Small ("S") = 250 Jumbo ("J") = 2,500		

Optional: Pieces Per Sleeve
While 1 marker per sleeve is standard, the sleeve can be split into multiple pieces.
Example: 2HX-187-2-WT-4 This "4" means the sleeve is slit into four pieces
Available options: 2, 3, or 4 pieces.

Recommended Ribbon Series: R4300, R6400, R6600

Recommended Printer Series: BradyPrinter i7100 Industrial Label Printer, BBP72 Double Sided Printer

Software Compatibility: Brady Workstation, LabelMark Labelling Software, CodeSoft 9 Labelling Software

PermaSleeve wire marking sleeves

B-7642 PermaSleeve HX self-extinguishing polyolefin wire marking sleeves, 2:1 shrink ratio

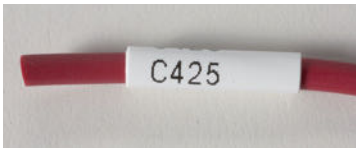

Single-sided printable, 38.10 mm width

Use the table below to browse all available single-sided printing, 38.10 mm width B-7642 PermaSleeve HX polyolefin wire marking sleeves.

Order Reference	Colour	Wire Diameter Range (mm)	Label Height B (mm)	Label Width A (mm)	Vertical Repeat D (mm)	Labels per Row	Total Quantity per pack	Printer Compatibility	Printer Ribbon Series
B-7642 : Heat-shrink Polyolefin									
HX-094-150-WT	White	1.19 to 2.03	4.62	38.10	12.70	1	2500	BBP12, BBP72, i7100	R6600
HX-125-150-WT	White	1.57 to 2.79	5.97	38.10	12.70	1	2500	BBP12, BBP72, i7100	R6600
HX-125-150-WT-2	White	1.57 to 2.79	5.97	19.05	12.70	2	5000	BBP12, BBP72, i7100	R6600
HX-125-150-WT-S	White	1.57 to 2.79	5.97	38.10	12.70	1	500	BBP12, BBP72, i7100	R6600
HX-187-150-WT	White	2.39 to 3.81	8.51	38.10	15.88	1	2500	BBP12, BBP72, i7100	R6600
HX-187-150-WT-2	White	2.39 to 3.81	8.51	19.05	15.88	2	5000	BBP12, BBP72, i7100	R6600
HX-187-150-WT-S	White	2.39 to 3.81	8.51	38.10	15.88	1	500	BBP12, BBP72, i7100	R6600
HX-250-150-WT	White	3.18 to 5.46	11.15	38.10	19.05	1	1000	BBP12, BBP72, i7100	R6600
HX-250-150-WT-2	White	3.18 to 5.46	11.15	19.05	19.05	2	2000	BBP12, BBP72, i7100	R6600
HX-375-150-WT	White	4.78 to 8.13	16.38	38.10	25.40	1	1000	BBP12, BBP72, i7100	R6600
HX-375-150-WT-2	White	4.78 to 8.13	16.38	19.05	25.40	2	2000	BBP12, BBP72, i7100	R6600
HX-500-150-WT	White	6.35 to 11.43	21.62	38.10	31.75	1	500	BBP12, BBP72, i7100	R6600
HX-500-150-WT-2	White	6.35 to 11.43	21.62	19.05	31.75	2	1000	BBP12, BBP72, i7100	R6600
HX-750-150-WT	White	9.53 to 17.78	31.75	38.10	41.28	1	250	BBP12, BBP72, i7100	R6600



Double-sided printable, 50.80 mm width

Use the table below to browse all available double-sided printing, 50.80 mm width B-7642 PermaSleeve HX polyolefin wire marking sleeves.

Order Reference	Colour	Wire Diameter Range (mm)	Label Height B (mm)	Label Width A (mm)	Vertical Repeat D (mm)	Labels per Row	Total Quantity per pack	Printer Compatibility	Printer Ribbon Series
B-7642 : Heat-shrink Polyolefin									
2HX-125-2-WT-2	White	1.57 to 2.79	5.97	25.40	12.70	2	5000	BBP12, BBP72, i7100	R6600
2HX-375-2-WT-2	White	4.78 to 8.13	16.38	25.40	25.40	2	2000	BBP12, BBP72, i7100	R6600
2HX-750-2-WT	White	9.53 to 17.78	31.75	50.80	41.28	1	250	BBP12, BBP72, i7100	R6600
2HX-750-2-WT-2	White	9.53 to 17.78	31.75	25.40	41.28	2	500	BBP12, BBP72, i7100	R6600
2HX-1000-2-WT	White	12.70 to 24.13	42.16	50.80	50.80	1	250	BBP12, BBP72, i7100	R6600

Choosing your PermaSleeve colour

While white is a standard colour, additional coloured sleeves are available as well. Simply replace "WT" with the abbreviation of the desired colour to order.

Example: HX-094-2-**WT**-S becomes HX-094-2-**RD**-S

Available colours:

WT = White GR = Green Orange VT = Violet
 BK = Black GY = Gray PK = Pink YL = Yellow
 BL = Blue OR = RD = Red

Choosing your PermaSleeve pieces (optional):

While 1 or 2 markers per sleeve is standard, you may also choose to have each sleeve slit multiple times to produce multiple pieces. Simply add the desired pieces per marker to the order reference.

Example: HX-187-150-WT-S becomes HX-187-150-WT-S-**4**
 This "4" means that this sleeve is slit into four pieces.

Standard options:

1 or 2 markers per sleeve

Other available slit options:

3 or 4 markers per sleeve
 (Contact Brady customer service for availability)

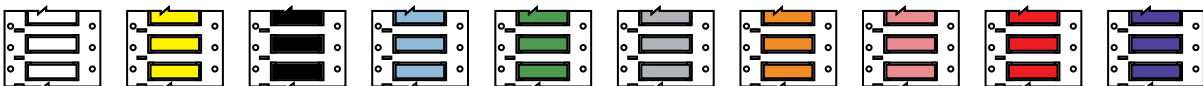

B-7642 PermaSleeve HX self-extinguishing polyolefin wire marking sleeves, 2:1 shrink ratio



Single-sided printable, 50.80 mm width

Use the table below to browse all available single-sided printing, 50.80 mm width B-7642 PermaSleeve HX polyolefin wire marking sleeves.

Order Reference	Colour	Wire Diameter Range (mm)	Label Height B (mm)	Label Width A (mm)	Vertical Repeat D (mm)	Labels per Row	Total Quantity per pack	Printer Compatibility	Printer Ribbon Series
B-7642 : Heat-shrink Polyolefin									
HX-094-2-WT	White	1.19 to 2.03	4.62	50.80	12.70	1	2500	BBP12, BBP72, i7100	R6600
HX-094-2-WT-2	White	1.19 to 2.03	4.62	25.40	12.70	2	5000	BBP12, BBP72, i7100	R6600
HX-125-2-WT	White	1.57 to 2.79	5.97	50.80	12.70	1	2500	BBP12, BBP72, i7100	R6600
HX-125-2-WT-2	White	1.57 to 2.79	5.97	25.40	12.70	2	5000	BBP12, BBP72, i7100	R6600
HX-125-2-WT-4	White	1.57 to 2.79	5.97	12.70	12.70	4	10000	BBP12, BBP72, i7100	R6600
HX-125-2-WT-S	White	1.57 to 2.79	5.97	50.80	12.70	1	500	BBP12, BBP72, i7100	R6600
HX-187-2-WT	White	2.39 to 3.81	8.51	50.80	15.88	1	2500	BBP12, BBP72, i7100	R6600
HX-187-2-WT-2	White	2.39 to 3.81	8.51	25.40	15.88	2	5000	BBP12, BBP72, i7100	R6600
HX-187-2-WT-S	White	2.39 to 3.81	8.51	50.80	15.88	1	500	BBP12, BBP72, i7100	R6600
HX-250-2-WT	White	3.18 to 5.46	11.15	50.80	19.05	1	2500	BBP12, BBP72, i7100	R6600
HX-250-2-WT-2	White	3.18 to 5.46	11.15	25.40	19.05	2	5000	BBP12, BBP72, i7100	R6600
HX-375-2-WT	White	4.78 to 8.13	16.38	50.80	25.40	1	1000	BBP12, BBP72, i7100	R6600
HX-375-2-WT-2	White	4.78 to 8.13	16.38	25.40	25.40	2	2000	BBP12, BBP72, i7100	R6600
HX-500-2-WT	White	6.35 to 11.43	21.62	50.80	31.75	1	500	BBP12, BBP72, i7100	R6600
HX-500-2-WT-2	White	6.35 to 11.43	21.62	25.40	31.75	2	1000	BBP12, BBP72, i7100	R6600
HX-750-2-WT	White	9.53 to 17.78	31.75	50.80	41.28	1	250	BBP12, BBP72, i7100	R6600
HX-750-2-WT-2	White	9.53 to 17.78	31.75	25.40	41.28	2	500	BBP12, BBP72, i7100	R6600
HX-1000-2-WT-S	White	12.70 to 24.13	42.16	50.80	50.80	1	100	BBP12, BBP72, i7100	R6600
HX-1500-2-WT	White	19.05 to 36.83	61.80	50.80	76.20	1	250	BBP12, BBP72, i7100	R6600
HX-2000-2-WT	White	25.40 to 49.53	80.39	50.80	101.60	1	100	BBP12, BBP72, i7100	R6600

◀ Choosing your PermaSleeve colour & Choosing your PermaSleeve pieces (optional): see previous page



QuickSleeve Handheld Sleeve Applicator (149474)

B-7646 PermaSleeve diesel resistant polyolefin wire marking sleeves, 3:1 shrink ratio

B-7646 PermaSleeves have been developed for wire and cable identification in applications that have exposures to organic fluids, common fuels, lubricants and solvents for extended periods of time and at high temperatures. These heat shrinkable wire marking sleeves have an operating temperature of -48 °C to 57 °C (-55 °F to 135 °F).

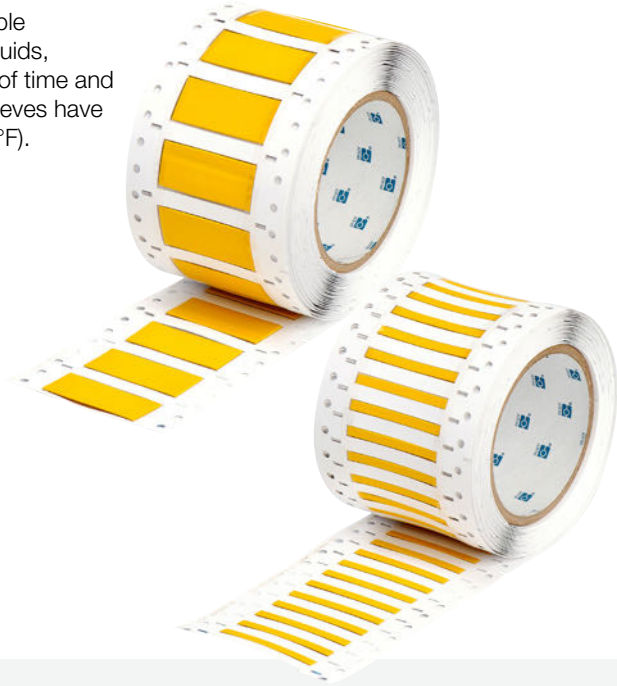

▶ How to read your PermaSleeve order reference

Example order reference:

3DPS - 3.2x50 - B7646-YL - 2S

Product	Max. Diameter	Width	Material & Colour	- 2S Pieces <small>Optional</small>
---------	---------------	-------	-------------------	---

Available options for B-7646 PermaSleeve Diesel Resistant Wire Marking Sleeve:

Product Type
3:1DPS = Double Sided Printing, B-7646 Brady format 3DPS = Double Sided Printing, B-7646 Universal format

Sleeve Diameter
2.4 size fits wire diameter 0.8 mm - 2.4 mm
3.2 size fits wire diameter 1.2 mm - 3.2 mm
4.8 size fits wire diameter 1.5 mm - 4.8 mm
6.4 size fits wire diameter 1.8 mm - 6.4 mm
9.5 size fits wire diameter 3.0 mm - 9.5 mm
12.7 size fits wire diameter 3.8 mm - 12.7 mm
19.1 size fits wire diameter 6.0 mm - 19.1 mm
25.4 size fits wire diameter 8.0 mm - 25.4 mm
38.1 size fits wire diameter 18.0 mm - 38.1 mm

Sleeve Width
2 = 50.80 mm

Sleeve Colour
Standard Colour for B-7646: YL = Yellow

Optional: Pieces Per Sleeve
While 1 marker per sleeve is standard, if desired, the sleeve can be split into multiple pieces. 3DPS-3.2x50mm-B7646-YL-2S This "2" means this sleeve is slit into two pieces Available options: 2, 3, or 4 pieces.

Recommended Ribbon Series: R6600 Series

Recommended Printer Series: BradyPrinter i7100 Industrial Label Printer, Brady IP Printer, BBP72 Double Sided Printer

Software Compatibility: Brady Workstation, LabelMark Labelling Software

B-7646 PermaSleeve diesel resistant polyolefin wire marking sleeves, 3:1 shrink ratio

Double-sided printable, 50.80 mm width, Brady format

Use the table below to browse all available double-sided printing, 50.80 mm width Brady format B-7646 PermaSleeve diesel resistant polyolefin wire marking sleeves.

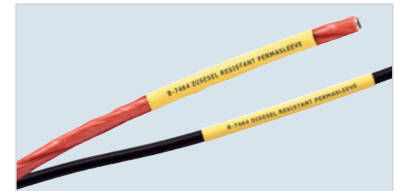

Order Reference	Colour	Wire Diameter Range (mm)	Label Height B (mm)	Label Width A (mm)	Vertical Repeat D (mm)	Labels per Row	Total Quantity per pack	Printer Compatibility	Printer Ribbon Series
B-7646 : Diesel-resistant Heat-shrink Polyolefin Sleeve									
3:1DPS-3.2x50-B7646-YL	Yellow	1.17 to 2.79	5.97	50.80	15.88	1	2500	BBP72	R6600
3:1DPS-3.2x50-B7646-YL-2S	Yellow	1.17 to 2.79	5.97	25.40	15.88	2	5000	BBP72	R6600
3:1DPS-3.2x50-B7646-YL-4S	Yellow	1.17 to 2.79	5.97	12.70	15.88	4	10000	BBP72	R6600
3:1DPS-4.8x50-B7646-YL	Yellow	1.57 to 3.81	8.51	50.80	19.05	1	2500	BBP72	R6600
3:1DPS-4.8x50-B7646-YL-2S	Yellow	1.57 to 3.81	8.51	25.40	19.05	2	5000	BBP72	R6600
3:1DPS-6.4x50-B7646-YL	Yellow	2.39 to 5.46	11.15	50.80	19.05	1	2500	BBP72	R6600
3:1DPS-6.4x50-B7646-YL-2S	Yellow	2.39 to 5.46	11.15	25.40	19.05	2	5000	BBP72	R6600
3:1DPS-9.5x50-B7646-YL	Yellow	3.18 to 8.13	16.38	50.80	25.40	1	1000	BBP72	R6600
3:1DPS-9.5x50-B7646-YL-2S	Yellow	3.18 to 8.13	16.38	25.40	25.40	2	2000	BBP72	R6600
3:1DPS-12.7X50-B7646-YL	Yellow	4.75 to 11.43	21.62	50.80	31.75	1	500	BBP72	R6600
3:1DPS-12.7X50-B7646-YL-2S	Yellow	4.75 to 11.43	21.62	25.40	31.75	2	1000	BBP72	R6600
3:1DPS-19X50-B7646-YL	Yellow	6.00 to 19.10	31.20	50.80	41.28	1	500	BBP72	R6600
3:1DPS-19X50-B7646-YL-2S	Yellow	6.00 to 19.10	31.20	25.40	41.28	2	1000	BBP72	R6600
3:1DPS-25X50-B7646-YL	Yellow	8.00 to 25.40	41.00	50.80	50.80	1	500	BBP72	R6600
3:1DPS-25X50-B7646-YL-2S	Yellow	8.00 to 25.40	41.00	25.40	50.80	2	1000	BBP72	R6600
3:1DPS-38X50-B7646-YL	Yellow	18.00 to 38.10	63.00	50.80	76.20	1	500	BBP72	R6600

Double-sided printable, 50.80 mm width, universal format

Use the table below to browse all available double-sided printing, 50.80 mm width universal Format B-7646 PermaSleeve diesel resistant polyolefin wire marking sleeves.

Order Reference	Colour	Wire Diameter Range (mm)	Label Height B (mm)	Label Width A (mm)	Vertical Repeat D (mm)	Labels per Row	Total Quantity per pack	Printer Compatibility	Printer Ribbon Series
B-7646 : Diesel-resistant Heat-shrink Polyolefin Sleeve									
3DPS-3.2x50mm-B7646YL	Yellow	1.20 to 3.20	6.60	50.00	12.70	1	2500	BBP72	R6600
3DPS-3.2x50mm-B7646YL-2S	Yellow	1.20 to 3.20	6.60	25.40	12.70	2	5000	BBP72	R6600
3DPS-3.2x50mm-B7646YL-2S (5Kx2)	Yellow	1.20 to 3.20	6.60	25.40	12.70	2	10000	BBP72	R6600
3DPS-3.2x50mm-B7646YL-3S	Yellow	1.20 to 3.20	6.60	17.02	12.70	3	7500	BBP72	R6600
3DPS-4.8x50mm-B7646YL	Yellow	1.50 to 4.80	9.20	50.00	12.70	1	2500	BBP72	R6600
3DPS-4.8x50mm-B7646YL-2S	Yellow	1.50 to 4.80	9.20	25.40	12.70	2	5000	BBP72	R6600
3DPS-4.8x50mm-B7646YL-3S	Yellow	1.50 to 4.80	9.20	17.02	12.70	3	7500	BBP72	R6600
3DPS-6.4x50mm-B7646YL	Yellow	1.80 to 6.40	11.25	50.00	17.02	1	2500	BBP72	R6600
3DPS-6.4x50mm-B7646YL-2S	Yellow	1.80 to 6.40	11.25	25.40	17.02	2	5000	BBP72	R6600
3DPS-9.5x50mm-B7646YL	Yellow	3.00 to 9.50	16.38	50.00	25.40	1	1000	BBP72	R6600
3DPS-9.5x50mm-B7646YL-2S	Yellow	3.00 to 9.50	16.38	25.40	25.40	2	2000	BBP72	R6600
3DPS-9.5x50mm-B7646YL-3S	Yellow	3.00 to 9.50	16.38	17.02	25.40	3	3000	BBP72	R6600
3DPS-12.7x50mm-B7646YL	Yellow	3.80 to 12.70	20.80	50.00	30.00	1	1000	BBP72	R6600
3DPS-12.7x50mm-B7646YL-2S	Yellow	3.80 to 12.70	20.80	25.40	30.00	2	2000	BBP72	R6600
3DPS-19.1x50mm-B7646YL	Yellow	6.00 to 19.10	31.20	50.00	42.00	1	1000	BBP72	R6600
3DPS-19.1x50mm-B7646YL-2S	Yellow	6.00 to 19.10	31.20	25.40	42.00	2	2000	BBP72	R6600
3DPS-25.4x50mm-B7646YL	Yellow	8.00 to 25.40	41.00	50.00	50.80	1	500	BBP72	R6600
3DPS-25.4x50mm-B7646YL-2S	Yellow	8.00 to 25.40	41.00	25.40	50.80	2	1000	BBP72	R6600
3DPS-38.1x50mm-B7646YL	Yellow	18.00 to 38.10	63.00	50.00	72.00	1	500	BBP72	R6600
3DPS-38.1x50mm-B7646YL-2S	Yellow	18.00 to 38.10	63.00	25.40	72.00	2	1000	BBP72	R6600

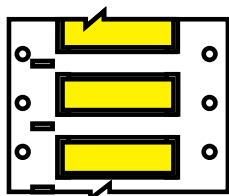

Choosing your PermaSleeve pieces (optional):

While 2 marker per sleeve is standard, you may also choose to have each sleeve slit multiple times to produce multiple pieces. Simply add the desired pieces per marker to the order reference.

Example: 3:1DPS-3.2x50mm-B7646-YL becomes 3:1DPS-3.2x50mm-B7646-YL-2S

This "2" means that this sleeve is slit into two pieces.

Available options: 2, 3, or 4 pieces.

Thermal transfer print ribbons

All Brady ribbons are developed to meet the performance requirements of the materials to be printed. The reason for this is that the bond between the ribbon and the label is critical to the success of the legend permanence. Please refer to the Ribbon/material cross reference chart on the following page to determine the appropriate ribbon/material combination.

Ribbon characteristics

Printer Ribbon Series	Formulation	Colour	Notes / Details
R4300	Wax/Resin	Black	Strong environmental resistance against smearing and chemicals. Also, reliable, sharp-edge print quality to maximise bar code readability.
R4400	Resin	Blue, Green, Red	High density ribbon, excellent solvent resistance, high heat resistance, and super scratch resistance.
R4500	Wax/Resin	Blue, Red, Silver	Strong environmental resistance against smearing and chemicals. Also, reliable, sharp-edge print quality to maximise bar code readability.
R4900	Resin	Black	This ribbon has superb smear resistance at high temperatures and superior solvent resistance.
R6000HF	Resin	Black	High density halogen free ribbon, excellent solvent resistance, high heat resistance, and super scratch resistance.
R6100	Wax/Resin	Black	Outstanding durability for a general purpose ribbon. Reduced printhead energy requirements.
R6200	Resin	Black	Designed for harsh environment labelling applications. Superior abrasion, chemical and heat resistance. Ribbons include spindle.
R6300	Resin	Black	High density ribbon, excellent solvent resistance, high heat and scratch resistance.
R6400	Resin	Black	Ultra high chemical resistance at high temperatures. Superior solvent resistance.
R6600	Resin	Black	Diesel resistant ribbon for thermal printing on Brady PermaSleeve™ and Heatex™ Sleeves. This ribbon has excellent chemical and abrasion resistance.
R6700	Wax/Resin	White	The White 6700 Series Thermal Transfer Ribbon offers high performance against scratching, smudging, and harsh chemicals. The ribbon can be used for printing on Brady's Black PermaSleeve™ materials.
R6800	Resin	White	Strong environmental resistance against smearing and chemicals. Also, reliable, sharp-edge print quality to maximise bar code readability.
R7940	Wax	Black	General purpose, standard performance wax ribbon for paper and temporary labelling.
R7942	Wax	Black	General purpose, standard performance wax ribbon for paper and temporary labelling.
R7950	Wax/Resin	Black, Blue, Green, Red	Strong environmental resistance against smearing and chemicals. Also, reliable, sharp-edge print quality to maximise bar code readability.
R7953	Wax/Resin	Black	Standard performance alternative wax/resin ribbon for R7950 with lower chemical and smear resistance.
R7960	Resin	Black	R7960, when printed on the appropriate Brady label, gives good solvent resistance, lower for alcohol, high print quality and excellent smear resistance.
R7961	Resin	Black	R7961 ribbon, when printed on the appropriate Brady label, gives excellent scratch and good chemical resistance.
R7962	Resin	Black	R7962 is a high performance resin ribbon which gives high smear and scratch resistance and excellent solvent and gas fuel resistance.
R7964	Resin	Black	R7964 ribbon, when printed on the appropriate Brady label, gives good chemical resistance to solvents and sharp printing.
R7990	Resin	Blue, Green, Red, White	Good solvent, smear and high heat resistance colour ribbon.



Ribbon / width cross reference guide

Ribbons THT 12.7 mm diameter core - ink side out

Width (mm)	Length (m)	Colour	Wax		Wax/Resin				Resin									
			R7940	R7942	R4500	R7950	R7953	R4400	R4900	R6000HF	R6400	R6600	R7960	R7961	R7964	R7990		
35.00	70.00	Black	R7940	-	-	R7950	-	-	R4900	-	-	-	R7960	-	-	-	-	-
56.00	70.00	Silver	-	-	R4500-SV	-	-	-	-	-	-	-	-	-	-	-	-	-
65.00	70.00	Black	R7940	-	-	R7950	R7953	-	R4900	R6000HF	R6400	-	R7960	-	R7964	-	-	-
85.00	70.00	Black	R7940	R7942	-	R7950	R7953	-	R4900	-	-	-	R7960	-	-	-	-	-
110.00	70.00	Black	R7940	R7942	-	R7950	R7953	-	R4900	R6000HF	R6400	R6600	R7960	R7961	R7964	-	-	-
110.00	70.00	Blue	-	-	-	R7950-BL	-	-	-	-	-	-	-	-	-	-	-	R7990-BL
110.00	70.00	Green	-	-	-	R7950-GR	-	-	-	-	-	-	-	-	-	-	-	R7990-GR
110.00	70.00	Red	-	-	-	R7950-RD	-	-	-	-	-	-	-	-	-	-	-	R7990-RD
110.00	70.00	White	-	-	-	-	-	-	R4400	-	-	-	-	-	-	-	-	R7990-WT

*102 mm wide x 74 m long.

Ribbons IP Printer (i5100)

Width (mm)	Length (m)	Colour	Wax/Resin				Resin						
			R4300	R4500	R6100	R6700	R4400	R4900	R6000HF	R6200	R6400	R6600	R6800
40.00	300.00	Black	R4300	-	-	-	-	-	IP-R6006HF	R6200	R6400	-	-
60.00	300.00	Black	R4300	-	R6100	-	-	R4400	R4900	IP-R6000HF	R6200	R6400	R6600
60.00	300.00	Blue	-	-	-	-	R4400	-	-	-	-	-	-
60.00	300.00	Green	-	-	-	-	R4400	-	-	-	-	-	-
60.00	300.00	Red	-	R4500	-	-	R4400	-	-	-	-	-	-
60.00	300.00	White	-	-	-	R6700	-	-	-	-	-	-	R6800
83.00	300.00	Black	R4300	-	R6100	-	-	R4900	R6000HF	R6200	R6400	R6600	-
83.00	300.00	Blue	-	R4500	-	-	R4400	-	-	-	-	-	-
83.00	300.00	Green	-	-	-	-	R4400	-	-	-	-	-	-
83.00	300.00	Red	-	R4500	-	-	R4400	-	-	-	-	-	-
83.00	300.00	Silver	-	R4500	-	-	-	-	-	-	-	-	-
83.00	300.00	White	-	-	-	R6700	R4400	-	-	-	-	-	R6800
110.00	300.00	Black	R4300	-	R6100	-	-	-	IP-R6007HF	R6200	R6400	R6600	-
110.00	300.00	Blue	-	R4500	-	-	R4400	-	-	-	-	-	-
110.00	300.00	Red	-	R4500	-	-	R4400	-	-	-	-	-	-
110.00	300.00	White	-	-	-	R6700	R4400	-	-	-	-	-	-

Ribbons THT 25.4 mm diameter core - ink side out

Width (mm)	Length (m)	Colour	Wax	Wax/Resin						Resin												
				R7942	R4300	R4500	R7950	R7953	R6100	R6700	R4400	R4900	R6000HF	R6200	R6300	R6400	R6600	R6800	R7960	R7961	R7962	R7964
25.40	300.00	Black	-	R4300	-	R7950	-	-	-	-	-	-	-	-	-	-	-	-	-	-	-	-
40.00	300.00	Black	R7942	R4300	-	R7950	-	-	-	-	-	R6006HF	R6200	R6300	R6400	R6600	-	R7960	-	-	-	-
60.00	300.00	Black	R7942	R4300	-	R7950	-	-	-	R4400	R4900	-	R6200	R6300	R6400	R6600	-	-	R7961	-	R7964	-
60.00	300.00	Blue	-	-	R4500	-	-	-	-	R4400	-	-	-	-	-	-	-	-	-	-	-	-
60.00	300.00	Green	-	-	-	-	-	-	-	R4400	-	-	-	-	-	-	-	-	-	-	-	-
60.00	300.00	Red	-	-	R4500	-	-	-	-	R4400	-	-	-	-	-	-	-	-	-	-	-	-
60.00	300.00	White	-	-	-	-	-	-	R6700	-	-	-	-	-	-	-	-	R6800	-	-	-	-
83.00	300.00	Black	-	R4300	-	R7950	R7953	-	-	-	R4900	R6002HF	R6200	R6300	R6400	R6600	-	-	-	-	-	-
83.00	300.00	Blue	-	-	R4500	-	-	-	-	R4400	-	-	-	-	-	-	-	-	-	-	-	-
83.00	300.00	Green	-	-	-	-	-	-	-	R4400	-	-	-	-	-	-	-	-	-	-	-	-
83.00	300.00	Red	-	-	R4500	-	-	-	-	R4400	-	-	-	-	-	-	-	-	-	-	-	-
83.00	300.00	Silver	-	-	R4500	-	-	-	-	-	-	-	-	-	-	-	-	-	-	-	-	-
83.00	300.00	White	-	-	-	-	-	-	R6700	R4400	-	-	-	-	-	-	-	R6800	-	-	-	-
90.00	300.00	Black	R7942	-	-	R7950	R7953	-	-	-	-	-	-	-	-	-	-	R7960	R7961	R7962	R7964	-
110.00	300.00	Black	R7942	R4300	-	R7950	R7953	R6100	-	-	-	-	R6200	R6300	R6400	R6600	-	-	R7961	R7962	R7964	-
110.00	300.00	Blue	-	-	-	-	-	-	-	R4400	-	-	-	-	-	-	-	-	-	-	-	-
110.00	300.00	Red	-	-	-	-	-	-	-	R4400	-	-	-	-	-	-	-	-	-	-	-	-
110.00	300.00	White	-	-	-	-	-	-	R6700	R4400	-	-	-	-	-	-	-	R6800	-	-	-	-
130.00	300.00	Black	-	R4300	-	R7950	-	-	-	-	R4900	-	-	-	-	-	-	-	-	-	-	-
130.00	300.00	White	-	-	-	-	-	-	-	-	-	-	-	-	-	-	-	-	-	-	-	-
170.00	300.00	Black	R7942	R4308	-	R7950	-	-	-	-	-	R6008HF	R6208	-	-	-	-	-	R7960	R7961	-	-

*320 m long instead of 300 m. **80 mm wide instead of 83 mm wide. *** 174 mm wide instead of 170mm wide.

Thermal transfer print ribbons

Ribbon / material cross-reference guide

To ensure the best legend permanence, all ribbons have been developed to meet the requirements of the materials to be printed on. Use the guide below to determine which ribbon series is recommended with your print materials.

- Recommended ribbon for use with respective material.
- ▲ Acceptable ribbon for use with respective material.
- U Materials are **UL** recognised with its respective ribbon.
- C Materials are **CSA** approved with its respective ribbon.
- cU Materials are **cUL** recognised with its respective ribbon.
- W White ribbon
- S Silver ribbon

B-#	Material	R4300	R4400	R4500	R4900	R6000HF	R6100	R6200	R6300	R6400	R6600	R6700	R6800	R7940	R7942	R7950	R7961
B-109	Polyethylene Tag	●	-	-	-	-	-	▲	-	-	-	-	-	-	-	●	▲
B-342	PermaSleeve	●	-	● S	-	-	-	-	-	-	-	● W	-	-	-	●	-
B-345	PermaSleeve	-	▲ W	-	-	●	-	-	-	-	▲	-	● W	-	-	-	-
B-350	Polyester/Paper	-	▲	-	● U	▲	-	-	-	-	-	-	-	-	-	-	-
B-351	Vinyl	-	-	-	-	▲	-	●	-	-	-	-	-	-	-	-	-
B-362	Vinyl	-	-	-	-	-	-	-	-	-	-	-	-	-	-	-	-
B-408	Paper	-	-	-	-	-	●	-	-	-	-	-	-	▲	▲	-	-
B-412	Polypropylene Tag	▲	-	-	-	-	-	●	-	-	-	-	-	-	-	▲	●
B-413	Polyester	-	●	-	▲	● cU / U	-	▲ cU	-	-	-	-	-	-	-	-	▲
B-422	Polyester	-	●	-	▲ U	● U	-	-	-	-	-	-	-	-	-	-	▲
B-423	Polyester	-	●	-	▲ U	● U	-	▲	-	-	-	-	-	-	-	-	▲
B-423Y	Polyester	-	-	-	-	● U	-	▲ U	-	-	-	-	-	-	-	-	-
B-424	Paper	●	-	▲	-	-	▲	-	-	-	-	-	-	▲	▲	●	-
B-425	Polypropylene	● U	-	●	-	-	-	● U / C	-	● U / C	-	-	-	-	-	●	▲ U / C
B-427	Vinyl	● U	-	▲	-	-	-	▲ U	-	-	-	-	-	-	-	●	▲
B-428	Polyester	● U / C	-	-	-	-	-	▲ C	-	-	-	-	-	-	-	● U	▲
B-430	Polyester	-	▲	-	▲ U	● U	-	▲	-	-	-	-	-	-	-	-	▲
B-432	Polyester	-	▲	-	▲ U	● U	-	▲	-	-	-	-	-	-	-	-	▲
B-434	Polyester	-	-	-	● U / C	● U	-	-	-	-	-	-	-	-	-	-	-
B-435	Polyester	-	-	-	▲ U	● U	-	-	-	-	-	-	-	-	-	-	-
B-437	Tedlar®	●	-	-	-	-	-	●	-	-	-	-	-	-	-	●	▲
B-438	Polyester	● U / C	-	▲	-	-	-	-	-	-	-	-	-	-	-	● U / C	-
B-439	Vinyl	-	▲ W	-	▲	●	-	-	-	-	-	-	-	-	-	-	-
B-449	Polyolefin	▲	-	-	-	-	-	●	-	-	-	-	-	-	-	▲	▲
B-459	Polyester	-	▲ U	-	▲ U / C	● U	-	-	-	-	-	-	-	-	-	-	-
B-473	Polyester	-	-	-	▲ U	● U	-	-	-	-	-	-	-	-	-	-	-
B-480	Polyester	-	●	-	▲	● cU / U	-	▲ U	-	-	-	-	-	-	-	-	▲
B-483	Polyester	-	▲	-	▲ U	● U	-	-	-	-	-	-	-	-	-	-	-
B-484	Polyester	-	▲	-	▲ U	● U	-	-	-	-	-	-	-	-	-	-	-
B-486	Polyester	● U / C	-	-	-	-	-	▲ C	-	-	-	-	-	-	-	●	▲
B-488	Polyester	● U / C	-	-	-	-	-	▲ U / C	-	-	-	-	-	-	-	●	▲
B-489	Polyester	● U / C	-	-	-	-	-	▲ U / C	-	-	-	-	-	-	-	●	▲
B-498	Vinyl Cloth	▲	-	-	-	▲	-	●	-	-	-	-	-	-	-	▲	▲
B-499	Nylon	▲ U / C	-	▲	● U / C	▲ U	-	▲	-	-	-	-	-	-	-	▲ U / C	▲
B-508	Nomex® Tag	●	-	-	-	-	-	-	-	-	-	-	-	-	-	●	▲
B-533	Polyester	-	●	-	▲	●	-	▲	-	-	-	-	-	-	-	-	-
B-593	Polyester	-	● U / W	-	-	● cU / U	-	-	-	-	-	-	-	-	-	-	-
B-642	Tedlar®	●	-	-	-	-	-	●	-	-	-	-	-	-	-	●	-
B-717	Polyimide	-	-	-	-	● U	-	-	-	-	-	-	-	-	-	-	-
B-718	Polyimide	-	-	-	-	● U	-	-	-	-	-	-	-	-	-	-	-
B-719	Polyimide	-	-	-	-	● U	-	-	-	-	-	-	-	-	-	-	-
B-724	Polyimide	●	-	-	-	-	-	-	-	-	-	-	-	-	-	●	-
B-727	Polyimide	-	-	-	-	● U	-	-	-	-	-	-	-	-	-	-	-
B-728	Polyimide	-	-	-	-	● U	-	-	-	-	-	-	-	-	-	-	-
B-729	Polyimide	-	-	-	-	● U	-	-	-	-	-	-	-	-	-	-	-
B-776	Polyimide	-	-	-	-	● U	-	-	-	-	-	-	-	-	-	-	-
B-777	Polyimide	-	-	-	●	-	-	-	● U	-	-	-	-	-	-	-	-
B-7351	Destructible Vinyl	-	-	-	-	●	-	-	-	-	-	-	-	-	-	-	-
B-7423	Polyester	-	-	-	-	●	-	-	-	-	-	-	-	-	-	-	▲
B-7425	Polypropylene	●	-	-	-	-	-	▲	-	●	-	-	-	-	-	●	▲
B-7546	Polyester	-	▲	-	-	● U	-	-	-	-	-	-	-	-	-	-	-
B-7563	Metallised Polyester	-	-	-	-	● U	-	-	-	-	-	-	-	-	-	-	▲ U
B-7566	Polyester	-	●	-	-	●	-	-	-	-	-	-	-	-	-	-	-
B-7576	Polyester	-	▲	-	-	● U	-	-	-	-	-	-	-	-	-	-	-
B-7593	Polyester	-	-	-	▲	●	-	-	-	-	-	-	-	-	-	-	-
B-7594	Polypropylene	-	-	-	-	-	-	-	-	-	-	-	-	-	-	-	● U
B-7597	Polyethylene	●	-	-	-	-	-	-	-	-	-	-	-	-	-	●	▲
B-7598	Polyethylene Tag	-	●	-	-	●	-	-	-	-	-	-	-	-	-	-	-
B-7599	Polyethylene Tag	●	-	-	-	-	-	-	-	-	-	-	-	-	-	●	▲
B-7606	Paper	●	-	-	-	-	-	-	-	-	-	-	-	▲	▲	●	-
B-7610	Paper	●	-	-	-	-	-	-	-	-	-	-	-	▲	▲	●	-
B-7641	Polyolefin	-	-	-	-	●	-	-	-	-	●	-	-	-	-	-	-
B-7642	Polyolefin	●	-	-	-	-	-	-	-	●	●	-	-	-	-	●	-
B-7643	Polyurethane	-	● W	-	▲	●	-	-	-	-	-	-	-	-	-	-	-
B-7646	Polyolefin Sleeve	-	-	-	-	-	-	-	-	-	●	-	-	-	-	-	-
B-7696	Vinyl Tag	-	-	-	-	●	-	-	-	-	-	-	-	-	-	-	-
B-7727	Polyimide	-	-	-	-	● U	-	-	-	-	-	-	-	-	-	-	-
B-8117	Polyester	-	▲ U / W	-	-	-	-	-	-	-	-	-	● U / W	-	-	-	-
B-8423	Polyester	-	▲	-	-	▲ U	-	● U / C	-	-	-	-	-	-	-	-	-
B-8591	Polymer	-	● U / W	-	-	-	-	-	-	-	● U	-	-	-	-	-	-

Nomex® and Tedlar® are registered trademarks of DuPont.

Surfing www.bradyeurope.com is a simple, efficient and timesaving way to learn more about BRADY products and applications, industry developments, events, promotions, etc. anytime, anywhere.

For looking up technical data sheets, downloading upgrades to your BRADY printers and software or fast registration of your BRADY products, there's just one address:

www.bradyeurope.com



www.bradyeurope.com

Africa

Randburg, South Africa
 Tel.: +27 11 704 3295
 Email: africa@bradycorp.com

Benelux

Zele, Belgium
 Tel.: +32 (0) 52 45 78 11
 Email: benelux@bradycorp.com

Central & Eastern Europe

Bratislava, Slovakia
 Tel.: +421 2 3300 4800
 Email: central_europe@bradycorp.com

Denmark

Odense
 Tel.: +45 66 14 44 00
 Email: denmark@bradycorp.com

France

Roncq
 Tel.: +33 (0) 3 20 76 94 48
 Email: france@bradycorp.com

Germany, Austria & Switzerland

Egelsbach, Germany
 Tel.: +49 (0) 6103 7598 660
 Email: germany@bradycorp.com

Hungary

Budaörs
 Tel.: +36 23 500 275
 Email: central_europe@bradycorp.com

Italy

Gorgonzola
 Tel.: +39 02 26 00 00 22
 Email: italy@bradycorp.com

Middle East FZE

Dubai, UAE
 Tel.: +971 4881 2524
 Email: me@bradycorp.com

Norway

Kjeller
 Tel.: +47 70 13 40 00
 Email: norway@bradycorp.com

Spain & Portugal

Madrid, Spain
 Tel.: +34 900 902 993
 Email: spain@bradycorp.com,
 portugal@bradycorp.com

Sweden, Finland, Baltic states

Kista, Sweden
 Tel.: +46 (0) 8 590 057 30
 Email: sweden@bradyeurope.com

Turkey

Istanbul
 Tel.: +90 212 264 02 20 / 264 02 21
 Email: turkey@bradycorp.com

UK & Ireland

Banbury, UK
 Tel.: +44 (0) 1295 228 288
 Email: uk@bradycorp.com

Our mission is to identify and protect people, products and premises



To help minimise our impact on the environment, Brady limits its number of reprints.

Updated versions are always available for download on www.bradyeurope.com.

 Search for: EUR-M-169-EN



Y4953966

Your distributor

12/08/2022